

Technical Reference



DPO7000, DSA/DPO70000 Series Digital Phosphor Oscilloscopes Specifications and Performance Verification

071-1732-05

This document applies to firmware version 1.0.4 and above.

Warning

The servicing instructions are for use by qualified personnel only. To avoid personal injury, do not perform any servicing unless you are qualified to do so. Refer to all safety summaries prior to performing service.

www.tektronix.com

Copyright © Tektronix. All rights reserved. Licensed software products are owned by Tektronix or its subsidiaries or suppliers, and are protected by national copyright laws and international treaty provisions.

Tektronix products are covered by U.S. and foreign patents, issued and pending. Information in this publication supercedes that in all previously published material. Specifications and price change privileges reserved.

TEKTRONIX and TEK are registered trademarks of Tektronix, Inc.

Pinpoint and RT-Eye are registered trademarks of Tektronix, Inc.

Contacting Tektronix

Tektronix, Inc.
14200 SW Karl Braun Drive
P.O. Box 500
Beaverton, OR 97077
USA

For product information, sales, service, and technical support:

- In North America, call 1-800-833-9200.
- Worldwide, visit www.tektronix.com to find contacts in your area.

Warranty 2

Tektronix warrants that this product will be free from defects in materials and workmanship for a period of one (1) year from the date of shipment. If any such product proves defective during this warranty period, Tektronix, at its option, either will repair the defective product without charge for parts and labor, or will provide a replacement in exchange for the defective product. Parts, modules and replacement products used by Tektronix for warranty work may be new or reconditioned to like new performance. All replaced parts, modules and products become the property of Tektronix.

In order to obtain service under this warranty, Customer must notify Tektronix of the defect before the expiration of the warranty period and make suitable arrangements for the performance of service. Customer shall be responsible for packaging and shipping the defective product to the service center designated by Tektronix, with shipping charges prepaid. Tektronix shall pay for the return of the product to Customer if the shipment is to a location within the country in which the Tektronix service center is located. Customer shall be responsible for paying all shipping charges, duties, taxes, and any other charges for products returned to any other locations.

This warranty shall not apply to any defect, failure or damage caused by improper use or improper or inadequate maintenance and care. Tektronix shall not be obligated to furnish service under this warranty a) to repair damage resulting from attempts by personnel other than Tektronix representatives to install, repair or service the product; b) to repair damage resulting from improper use or connection to incompatible equipment; c) to repair any damage or malfunction caused by the use of non-Tektronix supplies; or d) to service a product that has been modified or integrated with other products when the effect of such modification or integration increases the time or difficulty of servicing the product.

THIS WARRANTY IS GIVEN BY TEKTRONIX WITH RESPECT TO THE PRODUCT IN LIEU OF ANY OTHER WARRANTIES, EXPRESS OR IMPLIED. TEKTRONIX AND ITS VENDORS DISCLAIM ANY IMPLIED WARRANTIES OF MERCHANTABILITY OR FITNESS FOR A PARTICULAR PURPOSE. TEKTRONIX' RESPONSIBILITY TO REPAIR OR REPLACE DEFECTIVE PRODUCTS IS THE SOLE AND EXCLUSIVE REMEDY PROVIDED TO THE CUSTOMER FOR BREACH OF THIS WARRANTY. TEKTRONIX AND ITS VENDORS WILL NOT BE LIABLE FOR ANY INDIRECT, SPECIAL, INCIDENTAL, OR CONSEQUENTIAL DAMAGES IRRESPECTIVE OF WHETHER TEKTRONIX OR THE VENDOR HAS ADVANCE NOTICE OF THE POSSIBILITY OF SUCH DAMAGES.

Table of Contents

General Safety Summary	v
Service Safety Summary	vii
Environmental Considerations	ix
Specifications	1-1
Specification Tables	1-1
Certifications and Compliances	1-36
Performance Verification	2-1
Conventions	2-2
Brief Procedures	2-5
Self Tests	2-5
Verify Internal Adjustment, Self Compensation, and Diagnostics	2-5
Functional Tests	2-6
Verify All Input Channels	2-7
Verify the Time Base	2-9
Verify the A (Main) and B (Delayed) Trigger Systems	2-11
Verify the File System	2-13
Performance Tests	2-15
Prerequisites	2-15
Equipment Required	2-16
DPO7000 Series and DSA/DPO70000 Series Test Record	2-19
Signal Acquisition System Checks	2-37
Check DC Voltage Measurement Accuracy	2-37
Check DC Gain Accuracy, ≥ 4 GHz models	2-42
Check Offset Accuracy ≥ 4 GHz models	2-50
Check Analog Bandwidth, < 3.5 GHz models	2-54
Check Analog Bandwidth, ≥ 3.5 GHz models	2-59
Check Input Resistance, ≥ 4 GHz models	2-64
Time Base System Checks	2-66
Check Timbase and Delay Time Accuracy and Reference	2-66
Check Delta Time Measurement Accuracy, < 4 GHz models	2-69
Trigger System Checks	2-72
Check Time Qualified Trigger Accuracy	2-72
Check Sensitivity, Edge Trigger, DC Coupled	2-76
Output Signal Checks	2-84
Check Aux Trigger Out	2-84
Check Probe Compensation or Fast Edge Output	2-86
Serial Trigger Checks (Optional on Some Models)	2-91
Check Serial Trigger Baud Rate Limits	2-91
Check Serial Trigger Baud Rate Limits (≥ 4 GHz models Only)	2-96
Check Serial Trigger Clock Recovery Range	2-100
Sine Wave Generator Leveling Procedure	2-104

List of Figures

Figure 2-1: Toolbar and menu bar (< 4 GHz models shown)	2-3
Figure 2-2: Universal test hookup for functional tests - Ch 1 shown	2-7
Figure 2-3: Channel button location	2-8
Figure 2-4: Setup for time base test	2-10
Figure 2-5: Setup for trigger test	2-12
Figure 2-6: Setup for the file system test	2-14
Figure 2-7: Initial test hookup	2-37
Figure 2-8: Measurement of DC accuracy at maximum offset and position	2-41
Figure 2-9: Initial test hookup	2-42
Figure 2-10: Measurement of DC gain accuracy	2-49
Figure 2-11: Initial test hookup	2-51
Figure 2-12: Measurement of offset accuracy	2-53
Figure 2-13: Initial test hookup	2-55
Figure 2-14: Measurement of analog bandwidth	2-57
Figure 2-15: Initial test hookup	2-60
Figure 2-16: Measurement of analog bandwidth	2-63
Figure 2-17: Initial test hookup	2-64
Figure 2-18: Initial test hookup	2-66
Figure 2-19: Initial test hookup	2-67
Figure 2-20: Final test hookup	2-68
Figure 2-21: Delta time accuracy test hookup	2-69
Figure 2-22: Initial test hookup	2-73
Figure 2-23: Measurement of time accuracy for pulse and glitch triggering	2-73
Figure 2-24: Initial test hookup	2-77
Figure 2-25: Measurement of trigger sensitivity - 50 MHz results shown	2-79
Figure 2-26: Initial test hookup	2-84
Figure 2-27: Measurement of trigger out limits	2-86
Figure 2-28: Initial test hookup	2-87
Figure 2-29: Measurement of probe compensator frequency	2-88
Figure 2-30: Subsequent test hookup	2-89
Figure 2-31: Measurement of probe compensator amplitude	2-90
Figure 2-32: Initial test hookup	2-91

Figure 2-33: Isolated 0 triggering	2-93
Figure 2-34: Isolated 1 triggering	2-96
Figure 2-35: Initial test hookup	2-97
Figure 2-36: Initial test hookup	2-100
Figure 2-37: Clock recovery	2-103
Figure 2-38: Sine wave generator leveling equipment setup	2-104
Figure 2-39: Equipment setup for maximum amplitude	2-106

List of Tables

Table 1-1: Channel input and vertical specifications	1-1
Table 1-2: Horizontal and acquisition system specifications	1-15
Table 1-3: Trigger specifications	1-20
Table 1-4: Serial Trigger specifications (optional on < 4 GHz models DPO7000 Series)	1-27
Table 1-5: Input/output port specifications	1-30
Table 1-6: Data storage specifications	1-33
Table 1-7: Power source specifications	1-33
Table 1-8: Mechanical specifications	1-34
Table 1-9: Environmental specifications	1-35
Table 2-1: Vertical settings	2-8
Table 2-2: Test equipment	2-16
Table 2-3: DC Voltage measurement accuracy	2-39
Table 2-4: Gain accuracy	2-43
Table 2-5: Offset accuracy	2-52
Table 2-6: Analog bandwidth, < 3.5 GHz models	2-56
Table 2-7: Analog bandwidth	2-61
Table 2-8: Analog bandwidth	2-61
Table 2-9: Delta time measurement settings	2-70
Table 2-10: Trigger settings for \geq 4 GHz models	2-81
Table 2-11: Serial pattern data	2-92
Table 2-12: Word recognizer data	2-94
Table 2-13: Generator serial streams	2-98
Table 2-14: Serial pattern data	2-98
Table 2-15: Clock recovery input frequencies and baud rates	2-102

General Safety Summary

Review the following safety precautions to avoid injury and prevent damage to this product or any products connected to it.

To avoid potential hazards, use this product only as specified.

Only qualified personnel should perform service procedures.

While using this product, you may need to access other parts of a larger system. Read the safety sections of the other component manuals for warnings and cautions related to operating the system.

To Avoid Fire or Personal Injury

Use Proper Power Cord. Use only the power cord specified for this product and certified for the country of use.

Connect and Disconnect Properly. Do not connect or disconnect probes or test leads while they are connected to a voltage source.

Ground the Product. This product is grounded through the grounding conductor of the power cord. To avoid electric shock, the grounding conductor must be connected to earth ground. Before making connections to the input or output terminals of the product, ensure that the product is properly grounded.

Observe All Terminal Ratings. To avoid fire or shock hazard, observe all ratings and markings on the product. Consult the product manual for further ratings information before making connections to the product.

The inputs are not rated for connection to mains or Category II, III, or IV circuits.

Do not apply a potential to any terminal, including the common terminal, that exceeds the maximum rating of that terminal.

Do Not Operate Without Covers. Do not operate this product with covers or panels removed.

Power Disconnect. The power cord disconnects the product from the power source. Do not block the power cord; it must remain accessible to the user at all times.

Avoid Exposed Circuitry. Do not touch exposed connections and components when power is present.

Wear Eye Protection. Wear eye protection if exposure to high-intensity rays or laser radiation exists.

Do Not Operate With Suspected Failures. If you suspect there is damage to this product, have it inspected by qualified service personnel.

Do Not Operate in Wet/Damp Conditions.

Do Not Operate in an Explosive Atmosphere.

Keep Product Surfaces Clean and Dry.

Provide Proper Ventilation. Refer to the manual's installation instructions for details on installing the product so it has proper ventilation.

Symbols and Terms

Terms in this Manual. These terms may appear in this manual:



WARNING. *Warning statements identify conditions or practices that could result in injury or loss of life.*



CAUTION. *Caution statements identify conditions or practices that could result in damage to this product or other property.*

Terms on the Product. These terms may appear on the product:

DANGER indicates an injury hazard immediately accessible as you read the marking.

WARNING indicates an injury hazard not immediately accessible as you read the marking.

CAUTION indicates a hazard to property including the product.

Symbols on the Product. The following symbols may appear on the product:

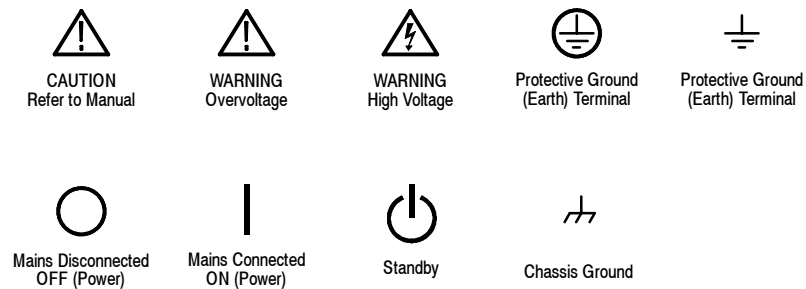

Service Safety Summary

Only qualified personnel should perform service procedures. Read this *Service Safety Summary* and the *General Safety Summary* before performing any service procedures.

Do Not Service Alone. Do not perform internal service or adjustments of this product unless another person capable of rendering first aid and resuscitation is present.

Disconnect Power. To avoid electric shock, switch off the instrument power, then disconnect the power cord from the mains power.

Use Care When Servicing With Power On. Dangerous voltages or currents may exist in this product. Disconnect power, remove battery (if applicable), and disconnect test leads before removing protective panels, soldering, or replacing components.

To avoid electric shock, do not touch exposed connections.

Environmental Considerations

This section provides information about the environmental impact of the product.

Product End-of-Life Handling

Observe the following guidelines when recycling an instrument or component:

Equipment Recycling. Production of this equipment required the extraction and use of natural resources. The equipment may contain substances that could be harmful to the environment or human health if improperly handled at the product's end of life. In order to avoid release of such substances into the environment and to reduce the use of natural resources, we encourage you to recycle this product in an appropriate system that will ensure that most of the materials are reused or recycled appropriately.



The symbol shown to the left indicates that this product complies with the European Union's requirements according to Directive 2002/96/EC on waste electrical and electronic equipment (WEEE). For information about recycling options, check the Support/Service section of the Tektronix Web site (www.tektronix.com).

Battery Recycling. This product may contain a Nickel Cadmium (NiCd) or lithium ion (Li-ion) rechargeable battery, which must be recycled or disposed of properly. Please properly dispose of or recycle the battery according to local government regulations.

Mercury Notification. This product uses an LCD backlight lamp that contains mercury. Disposal may be regulated due to environmental considerations. Please contact your local authorities or, within the United States, the Electronics Industries Alliance (www.eiae.org) for disposal or recycling information.

Restriction of Hazardous Substances

This product has been classified as Monitoring and Control equipment, and is outside the scope of the 2002/95/EC RoHS Directive. This product is known to contain lead, cadmium, mercury, and hexavalent chromium.

Specifications

This chapter contains the specifications for the instrument. All specifications are guaranteed unless labeled “typical.” Typical specifications are provided for your convenience but are not guaranteed. Specifications that are marked with the ✓ symbol are checked in this manual. All specifications apply to all models unless noted otherwise.

≥ 4 GHz models specifications apply to DSA70000 Series instruments unless noted otherwise.

To meet specifications, the following conditions must be met:

- The instrument must have been calibrated in an ambient temperature between 18 °C and 28 °C (64 °F and 82 °F).
- The instrument must be operating within the environmental limits listed in Table 1-9 on page 1-35.
- The instrument must be powered from a source that meets the specifications listed in Table 1-7 on page 1-33.
- The instrument must have been operating continuously for at least 20 minutes within the specified operating temperature range.
- You must perform the Signal Path Compensation procedure after the 20-minute warm-up period, and the ambient temperature must not change more than 5 °C without first repeating the procedure.

Specification Tables

Table 1-1: Channel input and vertical specifications

Characteristic	Description
Number of channels	4, all identical
Input connector	
≥ 4 GHz models	TekConnect.
< 4 GHz models	BNC and VPI probe
Input coupling	
≥ 4 GHz models	DC 50 Ω and GND. GND coupling disconnects the input connector from all channel input circuitry and connects a ground reference to the channel input circuitry.

Table 1-1: Channel input and vertical specifications (Cont.)

Characteristic	Description	
< 4 GHz models	DC, AC, or GND. GND coupling approximates ground reference by measuring an unused preamplifier input that has been connected to ground. The signal being measured is not disconnected from the channel input load.	
✓ Input resistance, ≥ 4 GHz models	50 Ω ±1.5% at 25 °C (77 °F), 50 Ω ± 2% over 10 to 45 °C (50 to 113 °F), type tested	
Input impedance, < 4 GHz models		
1 MΩ, DC coupled	1 MΩ ± 1% in parallel with 13 pF ± 2 pF	
50 Ω, DC coupled, typical	50 Ω ± 1%	
Maximum RMS input voltage, ≥ 4 GHz models	<1 V _{RMS} for <1.0 V/Full Scale settings and <5.5 V _{RMS} for ≥ 1.0 V/Full Scale settings	
Maximum Input Voltage, < 4 GHz models		
1 MΩ-DC coupled, 1 MΩ-AC coupled or GND coupled	150 V. Derate at 20 dB/decade to 9 V _{rms} above 200 kHz. The maximum input voltage at the BNC, between center conductor and ground is 400 V peak. The RMS voltage is limited to <150 V for arbitrary waveshapes including DC. The maximum pulse width for impulses with peaks over 150 V is 50 μs. Example: At 0 V to 400 V peak, rectangular wave, the duty factor is 14%. The maximum transient withstand voltage is ± 800 V peak.	
50Ω	5 V RMS, with peaks ≤ ± 24 V	
Input VSWR, typical		
≥ 4 GHz models Input Frequency	VSWR < 1 V/Full Scale	VSWR ≥ 1 V/Full Scale
<2.5 GHz	1.25	1.2
<6 GHz	1.5	1.2
<14 GHz	2.1	1.5
<15 GHz	2.5	1.5
	Measured with a TekConnect 2.92 mm adapter	
<15 GHz	2.5	1.5
< 4 GHz models	f _{in} <3.5 GHz	3.0
	f _{in} <2.5 GHz	2.0
	f _{in} <2 GHz	1.5
	f _{in} <1 GHz	1.2
Number of digitized bits	8 bits	
Digitizer nonlinearity, typical	< 1 digitization level (DL), differential; ≤ 1 DL integral, independently based	
Sensitivity range		
50 Ω, ≥ 4 GHz models	100 mV/Full Scale to 10 V/Full Scale, in a 1-2-5 sequence. Below 100 mV/Full Scale, Full Scale (FS) is software zoom.	

Table 1-1: Channel input and vertical specifications (Cont.)

Characteristic	Description	
50 Ω , < 4 GHz models	1 mV/div to 1 V/division, in a 1-2-5 sequence Fine adjustment available with $\geq 1\%$ resolution	
1 M Ω , < 4 GHz models	1 mV/div to 10 V/division, in a 1-2-5 sequence Fine adjustment available with $\geq 1\%$ resolution	
✓DC gain accuracy, sample or average acquisition mode, ≥ 4 GHz models	$\pm 2\%$	
DC gain accuracy, sample or average acquisition mode, < 4 GHz models	$\pm 1.0\%$ with 0 V offset Add 0.5% for ranges <2 mV/div Add 1.5% \times Net Offset/Offset Range for ranges <5 mV/div Add 0.5% for ranges ≥ 1 V/div in 1 M Ω coupling and with offset > 10 V	
✓ DC voltage measurement accuracy ≥ 4 GHz models	<i>Measurement type</i>	<i>DC accuracy (in volts)</i>
Average acquisition mode (≥ 16 averages)	100 mV/FS to 995 mV/FS	$\pm[(2\% \times \text{reading} - \text{net offset}) + 0.35\% \times \text{net offset} + 1.5 \text{ mV} + 0.014 \times \text{FS}]$
	1 V/FS to 10 V/FS	$\pm[(2\% \times \text{reading} - \text{net offset}) + 0.35\% \times \text{net offset} + 15 \text{ mV} + 0.014 \times \text{FS}]$
Delta voltage measurement between any two averages of ≥ 16 waveforms acquired under the same setup and ambient conditions	100 mV/FS to 10 V/FS	$\pm[(2\% \times \text{reading}) + 0.016 \times \text{FS}]$
✓ DC voltage measurement accuracy, < 4 GHz models	<i>DC accuracy (in volts)</i>	
Average acquisition mode (≥ 16 averages)	$\pm(\text{DC Gain Accuracy} \times \text{reading} - (\text{offset} - \text{position}) + \text{offset accuracy} + 0.1 \text{ division})$ For <5 mV/division settings: $\pm(\text{DC Gain Accuracy} \times \text{reading} - (\text{offset} - \text{position}) + \text{offset accuracy} + 0.1 \text{ division})$	
Delta voltage measurement between any two averages of ≥ 16 waveforms acquired under the same setup and ambient conditions	$\pm(\text{DC Gain Accuracy} \times \text{reading} + 0.05 \text{ division})$ For <5 mV/division settings: $\pm(\text{DC Gain Accuracy} \times \text{reading} + 0.05 \text{ division})$	
Sample acquisition mode, typical	$\pm(\text{DC Gain Accuracy} \times \text{reading} - (\text{offset} - \text{position}) + \text{offset accuracy} + 0.15 \text{ division} + 0.6 \text{ mV})$ For <5 mV/division: $\pm(\text{DC Gain Accuracy} \times \text{reading} - (\text{offset} - \text{position}) + \text{offset accuracy} + 0.15 \text{ division} + 0.6 \text{ mV})$	

Table 1- 1: Channel input and vertical specifications (Cont.)

Characteristic	Description	
Delta voltage measurement between any two samples acquired under the same setup and ambient conditions, typical	$\pm(\text{DC Gain Accuracy} \times \text{reading} + 0.15 \text{ division} + 1.2 \text{ mV})$	
	For <5 mV/division settings: $\pm(\text{DC Gain Accuracy} \times \text{reading} + 0.15 \text{ division} + 1.2 \text{ mV})$	
	Convert offset, position and the constant offset term to volts by multiplying by the appropriate volts/div. Specification applies to any sample and to the High, Low, Max, Min, Mean, Cycle Mean, RMS, and Cycle RMS measurements. Delta volts specification applies to subtractive calculations involving two of these measurements. Delta volts specification applies to the Positive Overshoot, Negative Overshoot, Pk-Pk, and amplitude measurements.	
Position range	± 5 divisions	
Offset range		
≥ 4 GHz models Offset is reduced to allow for position control according to the following formulas: 10 mV/div to 99.5 mV/div Offset range = $\pm(0.500 \text{ V} - (\text{V/div setting} * 5))$ 100 mV/div to 1 V/div Offset range = $\pm(0.500 \text{ V} - (\text{V/div setting} * 0.5))$	<i>SCALE range</i>	<i>Offset range</i>
	10 mV/div	$\pm 0.450 \text{ V}$
	20 mV/div	$\pm 0.400 \text{ V}$
	50 mV/div	$\pm 0.250 \text{ V}$
	100 mV/div	$\pm 4.50 \text{ V}$
	200 mV/div	$\pm 4.00 \text{ V}$
	500 mV/div	$\pm 2.50 \text{ V}$
	1 V/div	$\pm 0.00 \text{ V}$
< 4 GHz models, 50 Ω coupling	<i>SCALE range</i>	<i>Offset range</i>
	1 mV/div to 50 mV/div	$\pm 1.0 \text{ V}$
	50.5 mV/div to 99.5 mV/div	$\pm 1.5 \text{ V} - 10 \text{ divisions}$
	100 mV/div to 500 mV/div	$\pm 10 \text{ V}$
	505 mV/div to 1 V/div	$\pm 15 \text{ V} - 10 \text{ divisions}$
< 4 GHz models, 1 M Ω coupling	<i>SCALE range</i>	<i>Offset range</i>
	1 mV/div to 50 mV/div	$\pm 1 \text{ V}$
	50.5 mV/div to 99.5 mV/div	$\pm 1.5 \text{ V} - 10 \text{ divisions}$
	100 mV/div to 500 mV/div	$\pm 10 \text{ V}$
	505 mV/div to 995 mV/div	$\pm 15 \text{ V} - 10 \text{ divisions}$
	1.0 V/div to 5 V/div	$\pm 100 \text{ V}$
	5.05 V/div to 10 V/div	$\pm 150 \text{ V} - 10 \text{ divisions}$

Table 1- 1: Channel input and vertical specifications (Cont.)

Characteristic	Description	
Offset accuracy	<i>Net offset is the nominal voltage that must be applied to the channel to bring the trace to center screen. Net offset = offset - (position × volts/division). Offset accuracy is the accuracy of this voltage level.</i>	
✓ ≥ 4 GHz models	<i>SCALE range</i>	<i>Offset accuracy</i>
	10 mV/div to 99.5 mV/div	$\pm(0.35\% \times \text{net offset} + 1.5 \text{ mV} + 1\% \times \text{Full Scale})$
	100 mV/div to 1 V/div	$\pm(0.35\% \times \text{net offset} + 15 \text{ mV} + 1\% \times \text{Full Scale})$
< 4 GHz models	<i>SCALE range</i>	<i>Offset accuracy</i>
	1 mV/div to 9.95 mV/div	$\pm(0.2\% \times \text{net offset} + 1.5 \text{ mV} + 0.1 \text{ div} \times \text{V/div setting})$
	10 mV/div to 99.5 mV/div	$\pm(0.35\% \times \text{net offset} + 1.5 \text{ mV} + 0.1 \text{ div} \times \text{V/div setting})$
	100 mV/div to 1 V/div	$\pm(0.35\% \times \text{net offset} + 15 \text{ mV} + 0.1 \text{ div} \times \text{V/div setting})$
	1.01 V/div to 10 V/div	$\pm(0.25\% \times \text{net offset} + 150 \text{ mV} + 0.1 \text{ div} \times \text{V/div setting})$

Table 1- 1: Channel input and vertical specifications (Cont.)

Characteristic	Description		
✓ Analog bandwidth	DC 50 Ω coupling, Full bandwidth, TCA-292mm or TCA-N adapter		
Instrument	BW Settings ¹	Bandwidth	Temp Constraint ²
DPO72004	No DSP	>16 GHz, typical	<30 °C
20 GHz BWE	Enhanced BW	>18 GHz	<30 °C
100 mV and 1 V full scale (10 mv/div and 0.1 V/div)	Enhanced BW	>20 GHz	<30 °C
20 mV, 50 mV, 200 mV, and 500 mV/div	Enhanced BW	>18 GHz	<30 °C
18 GHz BWE	Enhanced BW	>18 GHz	<30 °C
DPO71604	No DSP	>16 GHz, typical	<30 °C
	Enhanced BW	>16 GHz	<30 °C
DPO71254	No DSP	>12.5 GHz	<40 °C
	Enhanced BW	>12.5 GHz	<40 °C
DPO70804	No DSP	>8 GHz	<45 °C
	Enhanced BW	>8 GHz	<45 °C
DPO70604	No DSP	>6 GHz	<45 °C
	Enhanced BW	>6 GHz	<45 °C
DPO70404	No DSP	>4 GHz	<45 °C
	Enhanced BW	>4 GHz	<45 °C
	Temperature Variation		
	Frequency	TC, (dB/ °C)	
	DC - 11 GHz	0	
	12.5 GHz	-0.02	
	16 GHz	-0.04	
	18 GHz	-0.08	
	20 GHz	-0.08	
	¹ Enhanced bandwidth only applies to full scale (FS) settings of 100 MV, 200 mV, 500 mV, 1 V, 2 V, and 5 V. Enhanced bandwidth of 4 GHz, 6 GHz, and 8 GHz is only available at 25 GS/s and 50 GS/s.		
	Enhanced bandwidth of 12.5 GHz, 16 GHz and 20 GHz is only available at 50 GS/s.		
	² Use the Temperature variation table to determine the amount of performance derating above the temperature limit.		
Analog bandwidth with P7313 active probe, typical	DPO72004 and DPO71604: DC >12.5 GHz		
	DPO71254:	DC >11 GHz	
	DPO70804:	DC >8 GHz	
	DPO70604:	DC >6 GHz	
	DPO70404:	DC >4 GHz	

Table 1-1: Channel input and vertical specifications (Cont.)

Characteristic	Description	
✓ Analog bandwidth	DC 50 Ω coupling, Full bandwidth, operating ambient of ≤ 30 °C (86 °F), derated by 1% for each °C above 30 °C (86 °F)	
	<i>SCALE range</i>	<i>Bandwidth</i>
		<i>BWE off</i> <i>BWE on</i>
DPO7354	10 mV/div to 1 V/div	DC to 2.5 GHz DC to 3.5 GHz
	5 mV/div to 9.9 mV/div	DC to 2.0 GHz
	2 mV/div to 4.99 mV/div	DC to 500 MHz
	1 mV/div to 1.99 mV/div	DC to 200 MHz
DPO7254	10 mV/div to 1 V/div	DC to 2.5 GHz
	5 mV/div to 9.9 mV/div	DC to 2.0 GHz
	2 mV/div to 4.99 mV/div	DC to 500 MHz
	1 mV/div to 1.99 mV/div	DC to 200 MHz
DPO7104	5 mV/div to 1 V/div	DC to 1.0 GHz
	2 mV/div to 4.99 mV/div	DC to 500 MHz
	1 mV/div to 1.99 mV/div	DC to 200 MHz
DPO7054	5 mV/div to 1 V/div	DC to 500 MHz
	2 mV/div to 4.99 mV/div	DC to 400 MHz
	1 mV/div to 1.99 mV/div	DC to 200 MHz
Analog bandwidth, 1 M Ω , DC coupled, typical, < 4 GHz models	Full bandwidth, operating ambient of ≤ 30 °C (86 °F), derated by 1% for each °C above 30 °C (86 °F)	
	<i>SCALE range</i>	<i>Bandwidth</i>
	5 mV/div to 10 V/div	DC to 500 MHz
	2 mV/div to 4.98 mV/div	DC to 350 MHz
	1 mV/div to 1.99 mV/div	DC to 175 MHz
Analog bandwidth with TAP2500 VPI probe, typical, DPO7254	Full bandwidth, operating ambient of ≤ 30 °C (86 °F), derated by 1% for each °C above 30 °C (86 °F)	
	<i>SCALE range</i>	<i>Bandwidth</i>
	≥ 100 mV/div	DC to 2.5 GHz
	50 mV/div to 99.58 mV/div	DC to 2.0 GHz
	20 mV/div to 49.8 mV/div	DC to 500 MHz
	10 mV/div to 19.9 mV/div	DC to 200 MHz

Table 1- 1: Channel input and vertical specifications (Cont.)

Characteristic	Description	
Analog bandwidth with X10 passive probe, typical, < 4 GHz models	Full bandwidth, operating ambient of $\leq 30\text{ }^{\circ}\text{C}$ (86 $^{\circ}\text{F}$), derated by 1% for each $^{\circ}\text{C}$ above 30 $^{\circ}\text{C}$ (86 $^{\circ}\text{F}$)	
	<i>SCALE range</i>	<i>Bandwidth</i>
	5 mV/div to 10 V/div	DC to 500 MHz
	2 mV/div to 4.98 mV/div	DC to 300 MHz
Analog bandwidth selections, < 4 GHz models	20 MHz, 250 MHz and Full	
Lower frequency limit, AC coupled, < 4 GHz models	10 Hz when 1 M, AC coupled The limit is reduced by a factor of 10 when 10X, passive probes are used.	
Upper frequency limit, 250 MHz bandwidth limited, < 4 GHz models	250 MHz	
Upper frequency limit, 20 MHz bandwidth limited, < 4 GHz models	20 MHz	

Table 1-1: Channel input and vertical specifications (Cont.)

Characteristic	Description			
Calculated rise time, 50 Ω , typical ¹	DSP On		DSP Off	
	10% - 90%	20% - 80%	10% - 90%	20% - 80%
DPO72004	22.5 ps		NA	NA
DPO71604	27.5 ps		30 ps	20 ps
DPO71254	34.3 ps		33 ps	23 ps
DPO70804	47 ps	33 ps	47 ps	32 ps
DPO70604	62 ps	43 ps	62 ps	43 ps
DPO70404	93 ps	65 ps	93 ps	65 ps
DPO7354 1 mV/div - 1.99 mV/div 2 mV/div - 4.99 mV/div 5 mV/div - 9.9 mV/div 10 mV/div - 1 V/div, BWE off 10 mV/div - 1 V/div, BWE on	1.2 ns 650 ps 180 ps 145 ps 110 ps			
DPO7254 1 mV/div - 1.99 mV/div 2 mV/div - 4.99 mV/div 5 mV/div - 9.9 mV/div 10 mV/div - 1 V/div	1.2 ns 650 ps 180 ps 160 ps			
DPO7104 1 mV/div - 1.99 mV/div 2 mV/div - 4.99 mV/div 5 mV/div - 9.9 mV/div 10 mV/div - 1 V/div	1.2 ns 580 ps 300 ps 300 ps			
DPO7054 1 mV/div - 1.99 mV/div 2 mV/div - 4.99 mV/div 5 mV/div - 9.9 mV/div 10 mV/div - 1 V/div	1.2 ns 680 ps 460 ps 460 ps			
Step response settling time, typical, \geq 4 GHz models	The time by which the step response enters and stays below the indicated % error. Step transition occurs at the 50% amplitude point of the step leading edge.			
	DSP off			
Instrument	Gain setting (FS)	\pm Step amplitude	Settling Error Amount	Time
DPO72004	100 mV - 10 V	\leq 100% FS, no more than \leq 50% FS overdrive	< 9% < 5.5% < 2.5% < 0.15%	150 ps 400 ps 3 ns 1 ms

Table 1- 1: Channel input and vertical specifications (Cont.)

Characteristic	Description			
DPO71604	100 mV - 10 V	≤ 100% FS, no more than ≤ 50% FS overdrive	< 9% < 45.5% < 2.5% < 0.15%	150 ps 400 ps 3 ns 1 ms
DPO71254	100 mV - 10 V	≤ 100% FS, no more than ≤ 50% FS overdrive	< 9% < 5.5% < 2.5% < 0.15%	150 ps 400 ps 3 ns 1 ms
DPO70804	100 mV - 10 V	≤ 100% FS, no more than 50% FS overdrive	< 6% < 3% < 2.5% < 0.15%	150 ps 600 ps 3 ns 1 ms
DPO70604	100 mV - 10 V	≤ 100% FS, no more than 50% FS overdrive	< 6% < 3% < 2.5% < 0.15%	200 ps 800 ps 3 ns 1 ms
DPO70404	100 mV - 10 V	≤ 100% FS, no more than 50% FS overdrive	< 6% < 3% < 2.5% < 0.15%	300 ps 1.2 ns 3 ns 1 ms
	DSP on			
Instrument	Gain setting (FS)	± Step amplitude	Settling Error Amount	Time
DPO72004	100 mV - 10 V	No overdrive	< 2.5% < 0.15%	100 ps 400 ps 3 ns 1 ms
DPO71604	100 mV - 10 V	No overdrive	< 2.5% < 0.15%	100 ps 400 ps 3 ns 1 ms
DPO71254	100 mV - 10 V	No overdrive	< 2.5% < 0.15%	100 ps 400 ps 3 ns 1 ms
DPO70804	100 mV - 10 V	≤ 100% FS, no more than 50% FS overdrive	< 6% < 3% < 2.5% < 0.15%	150 ps 600 ps 3 ns 1 ms

Table 1-1: Channel input and vertical specifications (Cont.)

Characteristic	Description						
DPO70604	100 mV - 10 V	≤ 100% FS, no more than 50% FS overdrive			< 6% < 3% < 2.5% < 0.15%	200 ps 800 ps 3 ns 1 ms	
DPO70404	100 mV - 10 V	≤ 100% FS, no more than 50% FS overdrive			< 6% < 3% < 2.5% < 0.15%	300 ps 1.2 ns 3 ns 1 ms	
Pulse response, peak detect, or envelope mode, typical < 4 GHz models	Sample rate setting				Minimum pulse width		
	≤ 10 GS/s				1 ÷ (sample rate) or 100 ps		
	≥ 40 MS/s				1 ÷ (sample rate) or 25 ps		
<p>This instrument uses analog peak detection for pulse capture in Peak Detect or Envelope mode at sample rates of 125 MS per second and slower. At faster sample rates the instrument uses conventional sampling.</p> <p>The minimum single pulse widths for 50% or greater amplitude capture for pulses greater than 2 divisions in magnitude.</p>							
Effective bits, typical ≥ 4 GHz models	Nine division sine wave input at the indicated frequency, sampled at 500 mV FS						
	Enhanced bandwidth						
Input frequency	DPO72004 20 GHz	DPO72004 18 GHz	DPO71604 16 GHz	DPO71254 12.5 GHz	DPO70804 8 GHz	DPO70604 6 GHz	DPO70404 4 GHz
10 MHz	5.0 bits	5.4 bits	5.7 bits	5.9 bits	5.7 bits	5.8 bits	6.0 bits
1 GHz	5.0 bits	5.4 bits	5.6 bits	5.8 bits	5.7 bits	5.8 bits	5.9 bits
2 GHz	4.9 bits	5.4 bits	5.6 bits	5.7 bits	5.7 bits	5.7 bits	5.8 bits
3 GHz	4.9 bits	5.3 bits	5.5 bits	5.6 bits	5.5 bits	5.6 bits	5.7 bits
4 GHz	4.8 bits	5.3 bits	5.5 bits	5.6 bits	5.5 bits	5.6 bits	5.7 bits
5 GHz	4.8 bits	5.2 bits	5.4 bits	5.5 bits	5.5 bits	5.5 bits	
6 GHz	4.7 bits	5.1 bits	5.3 bits	5.4 bits	5.4 bits	5.4 bits	
7 GHz	4.5 bits	5.0 bits	5.2 bits	5.5 bits	5.4 bits		
8 GHz	4.2 bits	4.4 bits	4.7 bits	5.6 bits	5.3 bits		
9 GHz	3.5 bits	3.7 bits	5.3 bits	5.6 bits			
10 GHz	2.8 bits	4.7 bits	5.5 bits	5.6 bits			
11 GHz	4.0 bits	5.2 bits	5.4 bits	5.6 bits			
12 GHz	4.8 bits	5.2 bits	5.4 bits	5.6 bits			
13 GHz	4.5 bits	5.1 bits	5.4 bits				

Table 1-1: Channel input and vertical specifications (Cont.)

Characteristic	Description						
14 GHz	4.4 bits	5.1 bits	5.3 bits				
15 GHz	4.5 bits	5.1 bits	5.3 bits				
16 GHz	4.5 bits	5.1 bits	5.3 bits				
17 GHz	4.4 bits	5.2 bits					
18 GHz	4.5 bits	5.1 bits					
19 GHz	4.6 bits						
20 GHz	4.8 bits						
	Without enhanced bandwidth						
Input frequency	DPO72004		DPO71604	DPO71254	DPO70804	DPO70604	<i>DPO70404</i>
10 MHz	5.4 bits		5.4 bits	5.6 bits	5.6 bits	5.7 bits	5.8 bits
1 GHz	5.4 bits		5.4 bits	5.5 bits	5.6 bits	5.7 bits	5.8 bits
2 GHz	5.3 bits		5.3 bits	5.4 bits	5.4 bits	5.6 bits	5.7 bits
3 GHz	5.3 bits		5.3 bits	5.4 bits	5.4 bits	5.5 bits	5.6 bits
4 GHz	5.2 bits		5.2 bits	5.3 bits	5.3 bits	5.4 bits	5.5 bits
5 GHz	5.2 bits		5.2 bits	5.3 bits	5.2 bits	5.3 bits	
6 GHz	5 bits		5 bits	5.2 bits	5.2 bits	5.3 bits	
7 GHz	4.9 bits		4.9 bits	5.1 bits	5.2 bits		
8 GHz	4.5 bits		4.5 bits	5.0 bits	5.2 bits		
9 GHz	4.3 bits		4.3 bits	5.0 bits			
10 GHz	4.0 bits		4.0 bits	5.1 bits			
11 GHz	4.3 bits		4.3 bits	5.2 bits			
12 GHz	3.8 bits		3.8 bits	5.1 bits			
13 GHz	4.1 bits		4.1 bits				
14 GHz	4.7 bits		4.7 bits				
15 GHz	4.7 bits		4.7 bits				
16 GHz	4.7 bits		4.7 bits				

Table 1-1: Channel input and vertical specifications (Cont.)

Characteristic	Description						
Noise, typical							
≥ 4 GHz models	Without enhanced bandwidth						
Gain setting	DPO72004	DPO71604	DPO71254	DPO70804	DPO70604	DPO70404	
10 mV	940 μ V	940 μ V	720 μ V	600 μ V	550 μ V	520 μ V	
15 mV	1.2 mV	1.2 mV	950 μ V	800 μ V	780 μ V	740 μ V	
20 mV	1.45 mV	1.45 mV	1.17 mV	1.0 mV	950 μ V	950 μ V	
30 mV	2.2 mV	2.2 mV	1.8 mV	1.5 mV	1.4 mV	1.4 mV	
40 mV	2.8 mV	2.8 mV	2.2 mV	2.0 mV	1.9 mV	1.9 mV	
50 mV	3.4 mV	3.4 mV	2.8 mV	2.3 mV	2.3 mV	2.3 mV	
80 mV	5.5 mV	5.5 mV	4.6 mV	4.0 mV	3.8 mV	3.8 mV	
90 mV	6.3 mV	6.3 mV	5.2 mV	4.4 mV	4.3 mV	4.3 mV	
100 mV	9.5 mV	9.5 mV	7.2 mV	6.0 mV	5.5 mV	5.2 mV	
200 mV	14.5 mV	14.5 mV	11.7 mV	9.7 mV	9.5 mV	9.5 mV	
500 mV	34 mV	34 mV	28 mV	23 mV	23 mV	23 mV	
1 V	68 mV	68 mV	58 mV	49 mV	46 mV	46 mV	
	Enhanced bandwidth						
Gain setting	DPO72004 20 GHz	DPO72004 18 GHz	DPO71604	DPO71254	DPO70804	DPO70604	DPO70404
10 mV	NA	970 μ V	660 μ V	590 μ V	560 μ V	500 μ V	440 μ V
15 mV	NA	1.2 mV	920 μ V	820 μ V	790 μ V	690 μ V	590 μ V
20 mV	2.6 mV	1.6 mV	1.15 mV	980 μ V	950 μ V	850 μ V	750 μ V
30 mV	3.7 mV	2.3 mV	1.65 mV	1.5 mV	1.5 mV	1.3 mV	1.1 mV
40 mV	4.7 mV	3.1 mV	2.2 mV	1.9 mV	1.9 mV	1.7 mV	1.5 mV
50 mV	4.5 mV	3.2 mV	2.6 mV	2.2 mV	2.2 mV	2.0 mV	1.8 mV
80 mV	7.2 mV	5.1 mV	4.2 mV	3.8 mV	3.8 mV	3.4 mV	2.9 mV
90 mV	7.6 mV	5.6 mV	4.6 mV	4.1 mV	4.2 mV	3.8 mV	3.3 mV
100 mV	NA	9.8 mV	7 mV	5.9 mV	6.0 mV	5.3 mV	4.5 mV
200 mV	24.7 mV	16 mV	11.5 mV	9.8 mV	9.4 mV	8.4 mV	7.4 mV
500 mV	44.4 mV	32 mV	25 mV	22 mV	22 mV	20 mV	18 mV
1 V	78 mV	61 mV	51 mV	45 mV	45 mV	41 mV	36 mV

Table 1-1: Channel input and vertical specifications (Cont.)

Characteristic	Description		
Channel-to-channel crosstalk (channel isolation)			
≥ 4 GHz models	Input frequency range (up to the rated bandwidth). Assumes two channels with the same scale settings		Isolation
	0 to 10 GHz		≥ 120:1
	> 10 GHz to 12 GHz		≥ 80:1
	> 12 GHz to 15 GHz		≥ 50:1
	> 15 GHz to 20 GHz		≥ 25:1
< 4 GHz models, typical	≥ 100:1 at ≤ 100 MHz and ≥ 30:1 at > 100 MHz up to the rated bandwidth.		
Delay between channels, full bandwidth, equivalent time, typical, ≥ 4 GHz models	≤ 100 ps between any two channels with the same scale and coupling settings. ≤ 50 ps delay change when enabling and disabling Channel Equalization (DSP matching).		
Delay between channels, typical, < 4 GHz models	≤ 100 ps between any two channels with the same scale and coupling settings with input impedance set to 50Ω, DC coupling and scale set at or above 10 mV/div.		
Internal probe power, < 4 GHz models	50 W maximum		
Probe power per probe < 4 GHz models	Voltage	Maximum Amperage	Voltage tolerance
	5 V	50 mA	± 5%
	12 V	2 A	± 10%

¹ **Rise time calculation: A simple formula relating these times to bandwidth for all instruments is not available. The instruments have been characterized with the typical rise times listed.**

Table 1-2: Horizontal and acquisition system specifications

Characteristic	Description		
Real-time sample rate range	<i>Number of channels acquired</i>	<i>Sample rate, maximum (Standard) (Option 2SR)</i>	
DPO70804, DPO70604, and DPO70404	All channels	Up to 25 GS/s	
DPO72004, DPO71604, and DPO71254	All channels	Up to 50 GS/s	
DPO7354 and DPO7254	1	40 GS/s	
	2	20 GS/s	
	3 or 4	10 GS/s	
DPO7104	1	20 GS/s	40 GS/s
	2	10 GS/s	20 GS/s
	3 or 4	5 GS/s	10 GS/s
DPO7054	1	10 GS/s	20 GS/s
	2	5 GS/s	10 GS/s
	3 or 4	2.5 GS/s	5 GS/s
Equivalent-time sample rate or interpolated waveform rate range	Equivalent-time acquisition can be enabled or disabled. When disabled, waveforms are interpolated at the fastest time base settings.		
≥ 4 GHz models	Up to 5TS/s		
< 4 GHz models	Up to 4TS/s		
Maximum record length, sample mode, ≥ 4 GHz models	Depends on the number of active channels and the record length options installed. Maximum record length is less in serial trigger mode, hi-res mode or when using the FIR filter.		
Standard on DPO70000 Series	50 GS/s or less	10,000,000 points (all channels)	
Option 2XL installed, standard on DSA70000 Series	50 GS/s or less	20,000,000 points (all channels)	
Option 5XL installed	50 GS/s or less	50,000,000 points (all channels)	
Option 10XL installed	50 GS/s or less	100,000,000 points (all channels)	

Table 1-2: Horizontal and acquisition system specifications (Cont.)

Characteristic	Description						
Maximum record length, sample mode, < 4 GHz models	Depends on the number of active channels and the record length options installed. Maximum record length is less in serial trigger mode, hi-res mode or when using the FIR filter.						
Standard, DPO7254	<table> <tr> <td>10 GS/s</td> <td>10,000,000 points (3 or 4 channels)</td> </tr> <tr> <td>20 GS/s or less</td> <td>20,000,000 points (2 channels)</td> </tr> <tr> <td>40 GS/s or less</td> <td>40,000,000 points (1 channel)</td> </tr> </table>	10 GS/s	10,000,000 points (3 or 4 channels)	20 GS/s or less	20,000,000 points (2 channels)	40 GS/s or less	40,000,000 points (1 channel)
10 GS/s	10,000,000 points (3 or 4 channels)						
20 GS/s or less	20,000,000 points (2 channels)						
40 GS/s or less	40,000,000 points (1 channel)						
DPO7104	<table> <tr> <td>5 GS/s</td> <td>10,000,000 points (3 or 4 channels)</td> </tr> <tr> <td>10 GS/s or less</td> <td>20,000,000 points (2 channels)</td> </tr> <tr> <td>20 GS/s or less</td> <td>40,000,000 points (1 channel)</td> </tr> </table>	5 GS/s	10,000,000 points (3 or 4 channels)	10 GS/s or less	20,000,000 points (2 channels)	20 GS/s or less	40,000,000 points (1 channel)
5 GS/s	10,000,000 points (3 or 4 channels)						
10 GS/s or less	20,000,000 points (2 channels)						
20 GS/s or less	40,000,000 points (1 channel)						
DPO7054	<table> <tr> <td>2.5 GS/s</td> <td>10,000,000 points (3 or 4 channels)</td> </tr> <tr> <td>5 GS/s or less</td> <td>20,000,000 points (2 channels)</td> </tr> <tr> <td>10 GS/s or less</td> <td>40,000,000 points (1 channel)</td> </tr> </table>	2.5 GS/s	10,000,000 points (3 or 4 channels)	5 GS/s or less	20,000,000 points (2 channels)	10 GS/s or less	40,000,000 points (1 channel)
2.5 GS/s	10,000,000 points (3 or 4 channels)						
5 GS/s or less	20,000,000 points (2 channels)						
10 GS/s or less	40,000,000 points (1 channel)						
Option 2RL installed, DPO7254	<table> <tr> <td>10 GS/s</td> <td>20,000,000 points (3 or 4 channels)</td> </tr> <tr> <td>20 GS/s or less</td> <td>40,000,000 points (2 channels only)</td> </tr> <tr> <td>40 GS/s or less</td> <td>80,000,000 points (1 channel only)</td> </tr> </table>	10 GS/s	20,000,000 points (3 or 4 channels)	20 GS/s or less	40,000,000 points (2 channels only)	40 GS/s or less	80,000,000 points (1 channel only)
10 GS/s	20,000,000 points (3 or 4 channels)						
20 GS/s or less	40,000,000 points (2 channels only)						
40 GS/s or less	80,000,000 points (1 channel only)						
DPO7104	<table> <tr> <td>5 GS/s</td> <td>20,000,000 points (3 or 4 channels)</td> </tr> <tr> <td>10 GS/s or less</td> <td>40,000,000 points (2 channels only)</td> </tr> <tr> <td>20 GS/s or less</td> <td>80,000,000 points (1 channel only)</td> </tr> </table>	5 GS/s	20,000,000 points (3 or 4 channels)	10 GS/s or less	40,000,000 points (2 channels only)	20 GS/s or less	80,000,000 points (1 channel only)
5 GS/s	20,000,000 points (3 or 4 channels)						
10 GS/s or less	40,000,000 points (2 channels only)						
20 GS/s or less	80,000,000 points (1 channel only)						
DPO7054	<table> <tr> <td>2.5 GS/s</td> <td>20,000,000 points (3 or 4 channels)</td> </tr> <tr> <td>5 GS/s or less</td> <td>40,000,000 points (2 channels only)</td> </tr> <tr> <td>10 GS/s or less</td> <td>80,000,000 points (1 channel only)</td> </tr> </table>	2.5 GS/s	20,000,000 points (3 or 4 channels)	5 GS/s or less	40,000,000 points (2 channels only)	10 GS/s or less	80,000,000 points (1 channel only)
2.5 GS/s	20,000,000 points (3 or 4 channels)						
5 GS/s or less	40,000,000 points (2 channels only)						
10 GS/s or less	80,000,000 points (1 channel only)						
Option 5RL installed, DPO7254	<table> <tr> <td>10 GS/s</td> <td>50,000,000 points (3 or 4 channels)</td> </tr> <tr> <td>20 GS/s or less</td> <td>100,000,000 points (2 channels only)</td> </tr> <tr> <td>40 GS/s or less</td> <td>200,000,000 points (1 channel only)</td> </tr> </table>	10 GS/s	50,000,000 points (3 or 4 channels)	20 GS/s or less	100,000,000 points (2 channels only)	40 GS/s or less	200,000,000 points (1 channel only)
10 GS/s	50,000,000 points (3 or 4 channels)						
20 GS/s or less	100,000,000 points (2 channels only)						
40 GS/s or less	200,000,000 points (1 channel only)						
DPO7104	<table> <tr> <td>5 GS/s</td> <td>50,000,000 points (3 or 4 channels)</td> </tr> <tr> <td>10 GS/s or less</td> <td>100,000,000 points (2 channels only)</td> </tr> <tr> <td>20 GS/s or less</td> <td>200,000,000 points (1 channel only)</td> </tr> </table>	5 GS/s	50,000,000 points (3 or 4 channels)	10 GS/s or less	100,000,000 points (2 channels only)	20 GS/s or less	200,000,000 points (1 channel only)
5 GS/s	50,000,000 points (3 or 4 channels)						
10 GS/s or less	100,000,000 points (2 channels only)						
20 GS/s or less	200,000,000 points (1 channel only)						
DPO7054	<table> <tr> <td>2.5 GS/s</td> <td>50,000,000 points (3 or 4 channels)</td> </tr> <tr> <td>5 GS/s or less</td> <td>100,000,000 points (2 channels only)</td> </tr> <tr> <td>10 GS/s or less</td> <td>200,000,000 points (1 channel only)</td> </tr> </table>	2.5 GS/s	50,000,000 points (3 or 4 channels)	5 GS/s or less	100,000,000 points (2 channels only)	10 GS/s or less	200,000,000 points (1 channel only)
2.5 GS/s	50,000,000 points (3 or 4 channels)						
5 GS/s or less	100,000,000 points (2 channels only)						
10 GS/s or less	200,000,000 points (1 channel only)						
Option 10RL installed, DPO7254	<table> <tr> <td>10 GS/s</td> <td>100,000,000 points (3 or 4 channels)</td> </tr> <tr> <td>20 GS/s or less</td> <td>200,000,000 points (2 channels only)</td> </tr> <tr> <td>40 GS/s or less</td> <td>400,000,000 points (1 channel only)</td> </tr> </table>	10 GS/s	100,000,000 points (3 or 4 channels)	20 GS/s or less	200,000,000 points (2 channels only)	40 GS/s or less	400,000,000 points (1 channel only)
10 GS/s	100,000,000 points (3 or 4 channels)						
20 GS/s or less	200,000,000 points (2 channels only)						
40 GS/s or less	400,000,000 points (1 channel only)						
Maximum record length, HiRes mode	Half the record length of sample mode						
Seconds/division range	<table> <tr> <td>< 4 GHz models</td> <td>Fastest sweep speed is 25 ps per division</td> </tr> <tr> <td>≥ 4 GHz models</td> <td>Fastest sweep speed is 20 ps per division</td> </tr> </table>	< 4 GHz models	Fastest sweep speed is 25 ps per division	≥ 4 GHz models	Fastest sweep speed is 20 ps per division		
< 4 GHz models	Fastest sweep speed is 25 ps per division						
≥ 4 GHz models	Fastest sweep speed is 20 ps per division						

Table 1-2: Horizontal and acquisition system specifications (Cont.)

Characteristic	Description
Acquisition update rate	Fast Acquisition on: 250,000 waveforms per second maximum
Time base delay time range	5 ns to 250 s
Internal time-base reference frequency	10 MHz
✓ Timebase and delay time accuracy (Long term sample rate accuracy)	
< 4 GHz models	± 2.5 ppm initial accuracy. Aging < 1 ppm per year.
≥ 4 GHz models	± 1.5 ppm initial accuracy. Aging < 1 ppm per year from date of factory calibration. Applies only when using the internal reference.
Aperture uncertainty, typical, ≥ 4 GHz models	Total: <250 fs rms for record durations less than 10 μs <350 fs rms for record durations less than 100 μs <650 fs rms for record durations less than 1 ms <15 parts/trillion for record durations less than 60 s <2 ps peak-to-peak for record durations less than 10 μs <3 ps peak-to-peak for record durations less than 100 μs <4 ps peak-to-peak for record durations less than 1 ms
Jitter noise floor, typical, ≥ 4 GHz models	Applies to time periods as long as 100 μs DPO72004: 400 fs DPO71604 300 fs DPO71254 300 fs DPO70804 450 fs DPO70604 450 fs DPO70404 450 fs Calculate the jitter noise floor (JNF) for a given instrument setting using the following formula: FS = full-scale setting (volts) A = signal amplitude as a fraction of full-scale trm = 10 - 90% displayed (or measured) rise time (sec) N = input-referred noise (volts rms) tj = short term aperture uncertainty (sec rms) $JNF = \sqrt{\left[\frac{N}{\{FS \times A\}} \times trm \right]^2 + tj^2} \quad (secrms)$
Timebase stability (sample rate jitter or jitter noise floor), typical, < 4 GHz models	Total: <1.0 ps peak for record durations less than 10 μs <2.5 ps rms for record durations less than 30 ms <65 parts/trillion for record durations less than 10 s

Table 1-2: Horizontal and acquisition system specifications (Cont.)

Characteristic	Description																					
Delta time measurement accuracy, typical, ≥ 4 GHz models	<p>An approximate formula to calculate delta-time measurement accuracy (DTA) for a given setting and input signal is given below (assumes insignificant signal content above Nyquist and insignificant error due to aliasing):</p> <p>A = input signal amplitude (volts) t_{rm} = 10 to 90% measured rise time (sec) N = input-referred noise (volts rms) t_j = short/medium term aperture uncertainty (sec rms) TBA = timebase accuracy (2 ppm) duration = delta-time measurement (sec) assume edge shape that results from Gaussian filter response</p> $DTA_{pk-pk} = 5 \times \sqrt{2 \times \left[\left[\frac{N}{A} \times t_{rm} \right]^2 + t_j^2 \right]} + TBA \times duration$ <p>(seconds peak-to-peak)</p> <p>For timer durations less than 100 ns, the rms jitter in DTA measurements can be estimated as:</p> $DTA_{rms} = \sqrt{2 \times \left[\left[\frac{N}{A} \times t_{rm} \right]^2 + t_j^2 \right]} \quad (seconds \ rms)$ <p>The term under the square-root sign is the stability and is due to TIE. The errors due to this term occur throughout a single-shot measurement. The second term is due to both the absolute center-frequency accuracy and the center-frequency stability of the timebase and varies between multiple single-shot measurements over the observation interval (the amount of time from the first single-shot measurement to the final single-shot measurement). The observation interval may not exceed 1 year.</p>																					
DPO72004: Enhanced bandwidth on, single shot, sample mode, assume full-scale setting of 500 mV and signal amplitude of 350 mV																						
10 to 90% rise time (trm)	<table border="1"> <thead> <tr> <th data-bbox="989 1516 1222 1619">Duration</th> <th data-bbox="1230 1516 1300 1619">DTA rms</th> <th data-bbox="1308 1516 1459 1619">DTA pk-pk</th> </tr> </thead> <tbody> <tr> <td data-bbox="989 1629 1222 1667">< 100 ns</td> <td data-bbox="1230 1629 1300 1667">556 fs</td> <td data-bbox="1308 1629 1459 1667">2.98 ps</td> </tr> <tr> <td data-bbox="989 1677 1222 1715">< 100 ns</td> <td data-bbox="1230 1677 1300 1715">608 fs</td> <td data-bbox="1308 1677 1459 1715">3.24 ps</td> </tr> <tr> <td data-bbox="989 1726 1222 1764">< 100 ns</td> <td data-bbox="1230 1726 1300 1764">639 fs</td> <td data-bbox="1308 1726 1459 1764">3.39 ps</td> </tr> <tr> <td data-bbox="989 1774 1222 1812">< 100 ns</td> <td data-bbox="1230 1774 1300 1812">783 fs</td> <td data-bbox="1308 1774 1459 1812">4.11 ps</td> </tr> <tr> <td data-bbox="989 1822 1222 1860">< 100 ns</td> <td data-bbox="1230 1822 1300 1860">948 fs</td> <td data-bbox="1308 1822 1459 1860">4.94 ps</td> </tr> <tr> <td data-bbox="989 1871 1222 1908">< 100 ns</td> <td data-bbox="1230 1871 1300 1908">1.12 ps</td> <td data-bbox="1308 1871 1459 1908">5.82 ps</td> </tr> </tbody> </table>	Duration	DTA rms	DTA pk-pk	< 100 ns	556 fs	2.98 ps	< 100 ns	608 fs	3.24 ps	< 100 ns	639 fs	3.39 ps	< 100 ns	783 fs	4.11 ps	< 100 ns	948 fs	4.94 ps	< 100 ns	1.12 ps	5.82 ps
Duration	DTA rms	DTA pk-pk																				
< 100 ns	556 fs	2.98 ps																				
< 100 ns	608 fs	3.24 ps																				
< 100 ns	639 fs	3.39 ps																				
< 100 ns	783 fs	4.11 ps																				
< 100 ns	948 fs	4.94 ps																				
< 100 ns	1.12 ps	5.82 ps																				

Table 1-2: Horizontal and acquisition system specifications (Cont.)

Characteristic	Description																												
	DPO71604: Enhanced bandwidth on, single shot, sample mode, assume full-scale setting of 500 mV and signal amplitude of 350 mV																												
	<table border="1"> <thead> <tr> <th>10 to 90% rise time (trm)</th> <th>Duration</th> <th>DTA rms</th> <th>DTA pk-pk</th> </tr> </thead> <tbody> <tr> <td>25 ps</td> <td>< 100 ns</td> <td>556 fs</td> <td>2.98 ps</td> </tr> <tr> <td>35 ps</td> <td>< 100 ns</td> <td>608 fs</td> <td>3.24 ps</td> </tr> <tr> <td>40 ps</td> <td>< 100 ns</td> <td>639 fs</td> <td>3.39 ps</td> </tr> <tr> <td>60 ps</td> <td>< 100 ns</td> <td>783 fs</td> <td>4.11 ps</td> </tr> <tr> <td>80 ps</td> <td>< 100 ns</td> <td>948 fs</td> <td>4.94 ps</td> </tr> <tr> <td>100 ps</td> <td>< 100 ns</td> <td>1.12 ps</td> <td>5.82 ps</td> </tr> </tbody> </table>	10 to 90% rise time (trm)	Duration	DTA rms	DTA pk-pk	25 ps	< 100 ns	556 fs	2.98 ps	35 ps	< 100 ns	608 fs	3.24 ps	40 ps	< 100 ns	639 fs	3.39 ps	60 ps	< 100 ns	783 fs	4.11 ps	80 ps	< 100 ns	948 fs	4.94 ps	100 ps	< 100 ns	1.12 ps	5.82 ps
10 to 90% rise time (trm)	Duration	DTA rms	DTA pk-pk																										
25 ps	< 100 ns	556 fs	2.98 ps																										
35 ps	< 100 ns	608 fs	3.24 ps																										
40 ps	< 100 ns	639 fs	3.39 ps																										
60 ps	< 100 ns	783 fs	4.11 ps																										
80 ps	< 100 ns	948 fs	4.94 ps																										
100 ps	< 100 ns	1.12 ps	5.82 ps																										
✓ Delta Time Measurement Accuracy < 4 GHz models	<p>For signals having amplitude greater than 5 divisions, reference level = 50%, filter set to sin(x)/x, acquired at 10 mV/div or greater. The displayed risetime/sample interval must be greater than 1.4 but less than 4. Extra error will occur for two channel measurements due to channel to channel skew.</p> <table border="1"> <tbody> <tr> <td>Single shot, sample or HiRes, full bandwidth</td> <td> $(0.06/\text{sample rate} + 2.5 \text{ ppm} \times \text{reading}) \text{ rms}$ $\pm (0.30/(\text{sample rate}) + (2.5 \text{ ppm} \times \text{reading})) \text{ peak}$ </td> </tr> <tr> <td>Average Mode, ≥ 100 averages, full bandwidth selected.</td> <td>$\pm (2.5 \text{ ppm} \times \text{reading} + 4 \text{ ps})$</td> </tr> </tbody> </table>	Single shot, sample or HiRes, full bandwidth	$(0.06/\text{sample rate} + 2.5 \text{ ppm} \times \text{reading}) \text{ rms}$ $\pm (0.30/(\text{sample rate}) + (2.5 \text{ ppm} \times \text{reading})) \text{ peak}$	Average Mode, ≥ 100 averages, full bandwidth selected.	$\pm (2.5 \text{ ppm} \times \text{reading} + 4 \text{ ps})$																								
Single shot, sample or HiRes, full bandwidth	$(0.06/\text{sample rate} + 2.5 \text{ ppm} \times \text{reading}) \text{ rms}$ $\pm (0.30/(\text{sample rate}) + (2.5 \text{ ppm} \times \text{reading})) \text{ peak}$																												
Average Mode, ≥ 100 averages, full bandwidth selected.	$\pm (2.5 \text{ ppm} \times \text{reading} + 4 \text{ ps})$																												

Table 1-3: Trigger specifications

Characteristic	Description	
Trigger jitter, DC coupled, main edge, random holdoff, typical	< 4 GHz models: 1.5 ps rms for low frequency, fast rise time signal ≥ 4 GHz models: 1 ps rms for low frequency, fast rise time signal	
✓ Edge trigger sensitivity, DC coupled, typical ≥ 4 GHz models < 4 GHz models	All sources, positive or negative edge, for vertical scale settings ≥10 mV/div and ≤1 V/div	
	<i>Trigger Source</i>	<i>Sensitivity</i>
	A Event trigger	≤ 4%FS from DC to 50 MHz ≤ 10%FS at 4 GHz ≤ 15%FS at 6 GHz ≤ 20%FS at 8 GHz ≤ 50%FS at 11 GHz
	B Event trigger	≤ 4%FS from DC to 50 MHz ≤ 10%FS at 4 GHz ≤ 15%FS at 6 GHz ≤ 50%FS at 9 GHz
	Auxiliary input	250 mV from DC to 50 MHz, increasing to 350 mV at 1 GHz
	<i>Trigger Source</i>	<i>Sensitivity</i>
	Main and Delayed trigger	≤ 0.7 div from DC to 50 MHz ≤ 1.2 div at 2.5 GHz ≤ 2.5 div at 3.5 GHz
	Auxiliary input	1 MΩ: 250 mV from DC to 50 MHz, increasing to 350 mV at 250 MHz 50 Ω: 150 mV from DC to 50 MHz, increasing to 200 mV at 1.8 GHz (not checked in manual)
	Video trigger, Ch1 - Ch4	0.6 to 2.5 divisions of video sync tip

Table 1-3: Trigger specifications (Cont.)

Characteristic	Description		
Edge trigger sensitivity, not DC coupled, typical <p style="text-align: center;">≥ 4 GHz models</p> <p style="text-align: center;">< 4 GHz models</p>	All sources, positive or negative edge, for vertical scale settings ≥10 mV/div and ≤1 V/div		
	<i>Trigger coupling</i>	<i>Sensitivity</i>	
	NOISE REJ	15%FS from DC to 50 MHz 35%FS at 3 GHz 50%FS at 5 GHz	
	AC	Same as DC-coupled limits for frequencies > 100 Hz, attenuates signals <100 Hz	
	HF REJ	Same as DC-coupled limits for frequencies < 20 kHz, attenuates signals > 20 kHz	
	LF REJ	Same as DC-coupled limits for frequencies > 200 kHz, attenuates signals < 200 kHz	
	<i>Trigger coupling</i>	<i>Sensitivity</i>	
	NOISE REJ	3 × the DC-coupled limits	
	AC	Same as DC-coupled limits for frequencies > 100 Hz, attenuates signals <100 Hz	
	HF REJ	Same as DC-coupled limits for frequencies < 20 kHz, attenuates signals > 20 kHz	
	LF REJ	Same as DC-coupled limits for frequencies > 200 kHz, attenuates signals < 200 kHz	
	Trigger level or threshold range <p style="text-align: center;">≥ 4 GHz models</p> <p style="text-align: center;">< 4 GHz models</p>		
		<i>Trigger Source</i>	<i>Range</i>
		Any channel	±120% × FS from center of screen
Auxiliary input		±5.5 V	
Line		0 V, Not settable	
<i>Trigger Source</i>		<i>Sensitivity</i>	
Any channel		±12 divisions from center of screen	
Auxiliary input		±5 V	
Line	Not settable		

Table 1-3: Trigger specifications (Cont.)

Characteristic	Description			
Trigger level or threshold accuracy, typical	Edge trigger, DC coupling			
	≥ 4 GHz models	<i>Trigger Source</i>	<i>Accuracy</i>	
		Channel 1, 2, 3, or 4	± [(2% × trigger level - net offset) + (3.5% × FS) + offset accuracy]	
	< 4 GHz models	Auxiliary	Not specified	
		<i>Trigger Source</i>	<i>Accuracy</i>	
		Channel 1, 2, 3, or 4	± [(2% × deflection) + (0.7 divisions × volts/division) + offset accuracy]	
Auxiliary		Not specified		
Trigger position error, typical	Edge trigger, DC coupling, for signals having a slew rate at the trigger point of ≥ 0.5 division/ns			
	≥ 4 GHz models	<i>Acquisition mode</i>	<i>Trigger Position Error</i>	
		Sample, Average	± (1 waveform interval + 50 ps)	
		Peak Detect, Envelope	± (2 waveform interval + 50 ps)	
	< 4 GHz models	<i>Acquisition mode</i>	<i>Trigger Position Error</i>	
		Sample, Average	± (1 waveform interval + 200 ps)	
Peak Detect, Envelope		± (2 waveform intervals + 200 ps)		
Time range for time-qualified triggers	300 ps to 1 s			
	≥ 4 GHz models	Setup/Hold Violation		
< 4 GHz models	Setup time:	-100 ns to +100 ns		
	Hold time:	-1 ns to +100 ns		
	Setup + hold time:	500 ps minimum		
	Timeout	400 ps to 1 s		
	Time qualified window, outside >1;	600 ps to 1 s		
	All other types:	300 ps to 1 s		
✓ Time-qualified trigger timer accuracy	For Glitch, Width, Time qualified runt, Transition, or Setup/hold violation types			
		<i>Time range</i>	<i>Accuracy</i>	
	< 4 GHz models	<1 μs (<2 ns typical)	±(20% of setting + 0.5 ns)	
		1 μs to 1 s	±(0.01% of setting + 100 ns)	

Table 1-3: Trigger specifications (Cont.)

Characteristic	Description			
≥ 4 GHz models	Glitch and width triggering (300 ps to 1.0 ns typical)			
	<300 ns to 1.01 μs	±(3% of setting + 80 ps)		
	1.02 μs to 1 s	±(TB accuracy + 100 ns)		
	Other time-qualified types (300 ps to 1.0 ns typical)			
	<300 ps to 1.01 μs	±(5% of setting + 200 ps)		
	1.02 μs to 1 s	±(TB accuracy + 20 ns)		
Width and glitch trigger sensitivity, typical < 4 GHz models ≥ 4 GHz models	1.0 division from DC to 1 GHz (at input connector)			
	15% x FS from DC to 1 GHz, not violating the minimum timing requirements for each type (for vertical settings from 10 mV/div to 1 V/div at input connector)			
Width and glitch trigger, minimum timing requirements, < 4 GHz models	For vertical scale settings 10 mV/div and 1 V/div			
		<i>Minimum pulse width</i>	<i>Minimum rearm time</i>	Setup time Hold time
	Width type	225 ps	250 ps	N.A. N.A.
	Logic qualified width type	190 ps	250 ps	40 ps 175 ps
	Glitch type	170 ps	250 ps	N.A. N.A.
	Logic qualified glitch type	100 ps	250 ps	40 ps 60 ps
Width and glitch trigger, minimum timing requirements, ≥ 4 GHz models	For vertical scale settings 10 mV/div and 1 V/div			
		<i>Minimum pulse width</i>	<i>Minimum rearm time</i>	Setup time Hold time
	Width and glitch types	150 ps	300 ps	N.A. N.A.
	Logic qualified width and glitch types	150 ps	300 ps	20 ps 40 ps

Table 1-3: Trigger specifications (Cont.)

Characteristic	Description			
Runt trigger sensitivity, typical < 4 GHz models ≥ 4 GHz models	1.0 division (at input connector)			
	15% x FS from DC to 1 GHz, not violating the minimum timing requirements for each type (for vertical settings from 10 mV/div to 1 V/div at input connector)			
Runt trigger, minimum timing requirements, < 4 GHz models	A runt event occurs at the end of the runt whether or not the runt was time qualified. Logic qualified runt triggers require that the logic condition be true during the entire duration of the runt plus some minimum amount of time after the runt event occurred.			
		<i>Minimum pulse width</i>	<i>Minimum rearm time</i>	Setup time Hold time
	Runt type	225 ps	250 ps	N.A. N.A.
	Time qualified runt type	360 ps	450 ps	N.A. N.A.
	Logic qualified runt type	Runt width + 150 ps	250 ps	160 ps -16 ps
	Time and logic qualified runt type	Runt width + 330 ps	250 ps	160 ps 175 ps
Runt trigger, minimum timing requirements, ≥ 4 GHz models	A runt event occurs at the end of the runt whether or not the runt was time qualified. Logic qualified runt triggers require that the logic condition be true during the entire duration of the runt plus some minimum amount of time after the runt event occurred.			
		<i>Minimum pulse width</i>	<i>Minimum rearm time</i>	Setup time Hold time
	Runt type	200 ps	300 ps	N.A. N.A.
	Time qualified runt type	476 ps	510 ps	N.A. N.A.
	Logic qualified runt type	200 ps	300 ps	300 ps 300 ps
	Time and logic qualified runt type	520 ps	360 ps	160 ps 105 ps
Pattern and state trigger sensitivity, DC coupled, typical < 4 GHz models ≥ 4 GHz models	1.0 division from DC to 1 GHz (for vertical settings from 10 mV/div to 1 V/div at input connector)			
	15% x FS from DC to 1 GHz, not violating the minimum timing requirements for each type (for vertical settings from 10 mV/div to 1 V/div at input connector)			
Pattern and state trigger, minimum timing requirements, typical	Minimum duration of logic state: 100 ps (10 GB/s). The minimum duration of the logic pattern includes delay mismatch between channels.			
		<i>Minimum pulse width</i>		Rearm time
	Logic type	100 ps (10 GB/s)		100 ps
	State type	500 ps		500 ps
	Time qualified logic type	300 ps		500 ps

Table 1-3: Trigger specifications (Cont.)

Characteristic	Description			
Auxiliary trigger input characteristics and range, typical				
≥ 4 GHz models	50 Ω , ± 5 V (DC + peak AC)			
< 4 GHz models	50 Ω , $\pm 5\%$; maximum input voltage ± 5 V (DC + peak AC) 1 M Ω , $\pm 5\%$, 150 V CAT1. Derate at 20 dB/decade to 9 V _{rms} above 200 kHz			
Video-type trigger formats and field rates, < 4 GHz models	Triggers from negative sync composite video, field 1 or field 2 for interlaced systems, any field, specific line, or any line for interlaced or non-interlaced systems. Supported systems include NTSC, PAL, SECAM, and HDTV 1080/24sF, 1080p/25, 1080i/50, 1080i/60, 1080p/24, 720p/60, 480p/60.			
Timeout trigger, minimum timing requirements, < 4 GHz models	Timeout event occurs after the signal has stayed in some state the minimum amount of time. Setup and hold times are how long before and after the timeout event the logic level must remain valid in order to generate a trigger.			
	<i>Maximum ignored pulse width</i>	<i>Minimum rearm time</i>	Setup time	Hold time
Timeout type	300 ps	500 ps + pulse width	N.A.	N.A.
Logic qualified timeout type	300 ps	500 ps + pulse width	200 ps	200 ps
Timeout trigger, minimum timing requirements, ≥ 4 GHz models	Timeout event occurs after the signal has stayed in some state the minimum amount of time. Setup and hold times are how long before and after the timeout event the logic level must remain valid in order to generate a trigger.			
	<i>Maximum ignored pulse width</i>	<i>Minimum rearm time</i>	Setup time	Hold time
Timeout type	N.A.	300 ps + pulse width	N.A.	N.A.
Logic qualified timeout type	N.A.	300 ps + pulse width	50 ps	50 ps
Window trigger, minimum timing requirements, < 4 GHz models				
	<i>Minimum pulse width</i>	<i>Minimum rearm time</i>	Setup time	Hold time
Window	225 ps	300 ps	N.A.	N.A.
Logic qualified window	190 ps	300 ps	-20 ps	0 ps

Table 1-3: Trigger specifications (Cont.)

Characteristic	Description				
Window trigger, minimum timing requirements, ≥ 4 GHz models		<i>Minimum pulse width</i>	<i>Minimum rearm time</i>	Setup time	Hold time
	Window enters	150 ps	500 ps	N.A.	N.A.
	Window exits	500 ps	150 ps	N.A.	N.A.
	Logic qualified window enters	150 ps	500 ps	N.A.	N.A.
	Logic qualified window exits	500 ps	150 ps	N.A.	N.A.
	Window inside >t	N.A.	500 ps	N.A.	N.A.
	Window outside >t	N.A.	150 ps	N.A.	N.A.
	Transition trigger, minimum timing requirements, < 4 GHz models	The transition trigger event occurs at the end of the transition. The logic condition must be valid at the moment the transition event occurs minus the setup time plus the hold time.			
		<i>Minimum pulse width</i>	<i>Minimum rearm time</i>	Setup time	Hold time
Transition type		0 ps	225 ps	N.A.	N.A.
Logic qualified transition type	330 ps	225 ps	225 ps	175 ps	
Transition trigger, minimum timing requirements, ≥ 4 GHz models	The transition trigger event occurs at the end of the transition. The logic condition must be valid at the moment the transition event occurs minus the setup time plus the hold time. Rearm time is the time below the lower threshold and the time above the upper threshold. Neither time can be violated.				
		<i>Minimum pulse width</i>	<i>Minimum rearm time</i>	Setup time	Hold time
	Transition type	0 ps	500 ps	N.A.	N.A.
	Logic qualified transition type	0 ps	500 ps	50 ps	50 ps
Transition trigger, delta time range	1 ns to 1 s				
Setup/Hold violation trigger, setup and hold time ranges		<i>Minimum</i>		<i>Maximum</i>	
	Setup time	-100 ns		100 ns	
	Hold time	-1 ns		102 ns	
	Setup + hold time	500 ps			
	Setup/hold time violation trigger, minimum clock pulse widths, typical < 4 GHz models	Minimum time from active clock edge to inactive edge		Minimum time from inactive clock edge to active edge	
Hold times ≥ 0:		Hold time + 500 ps	500 ps		
	Hold times < 0:	Hold time + 1.5 ns			

Table 1-3: Trigger specifications (Cont.)

Characteristic	Description			
≥ 4 GHz models	Hold times ≥ 0:	Hold time + 550 ps	500 ps	
	Hold times <0:	Hold time + 1.6 ns		
Pattern and State trigger, minimum timing requirements, ≥ 4 GHz models, typical	The transition trigger event occurs at the end of the transition. The logic condition must be valid at the moment the transition event occurs minus the setup time plus the hold time.			
	<i>Minimum pulse width</i>	<i>Minimum rearm time</i>	Setup time	Hold time
Pattern type	150 ps	200 ps	N.A.	N.A.
State type	1.7 GHz	N.A.	25 ps	100 ps
Period trigger sensitivity, typical, < 4 GHz models	1.0 division (at input connector)			
Period trigger sensitivity, typical, ≥ 4 GHz models	1.5 divisions (at input connector)			
B trigger after events, minimum timing requirements, typical, < 4 GHz models	<i>Minimum pulse width</i>		Minimum time between channels	
	200 ps		1 ns	
B trigger after events, minimum timing requirements, typical, ≥ 4 GHz models	<i>Minimum pulse width</i>	<i>Maximum counting frequency</i>	Minimum time between channels	
	140 ps	3.5 GHz	1.0 ns	
B trigger after events, event counter range, < 4 GHz models	1 to 10,000,000			
B trigger after events, event counter range, ≥ 4 GHz models	1 to 2,000,000,000			
B trigger after events, time delay range	< 4 GHz models:	5 ns to 250 s		
	≥ 4 GHz models	3.2 ns to 3 Ms		
Variable A event trigger holdoff range	250 ns to 12 s + random holdoff			
Lowest frequency for successful Set Level to 50%, typical	50 Hz			

Table 1-4: Serial Trigger specifications (optional on < 4 GHz models DPO7000 Series)

Characteristic	Description
Serial trigger number of bits	
< 4 GHz models	64 bits
≥ 4 GHz models	40 bits, 64 bits for data rates ≤ 1.25 GBaud

Table 1-4: Serial Trigger specifications (optional on < 4 GHz models DPO7000 Series) (Cont.)

Characteristic	Description																																						
Serial trigger decoding types																																							
< 4 GHz models	NRZ																																						
≥ 4 GHz models	≤ 1.25 GB: NRZ 1.25 GB to 3.125 GB: 8B10B																																						
✓ Serial trigger baud rate limits																																							
< 4 GHz models	Up to 1.25 GBd (Option PTM adds protocol trigger to DPO7000 Series)																																						
≥ 4 GHz models	Up to 3.125 GBd, >1.25 GBaud requires 8B10B encoded data																																						
✓ Clock recovery frequency range																																							
< 4 GHz models	1.5 MBd to 1.25 GBd.																																						
≥ 4 GHz models	1.5 MBd to 3.125 GBd. Above 1250 MHz the clock is only available internally as a trigger source. Below 1250 MHz the clock is also available at the BERT Clock output along with regenerated data.																																						
Clock recovery jitter, typical																																							
≥ 4 GHz models	< 0.25% bit period + 2 ps rms for PRBS data patterns with 50% transition density. < 0.25% bit period + 1.5 ps rms for repeating 0011 data patterns.																																						
	<table border="1"> <thead> <tr> <th rowspan="2">Bit rate</th> <th rowspan="2">Pattern</th> <th colspan="2">Jitter (ps rms)</th> </tr> <tr> <th>PRBS</th> <th>0011</th> </tr> </thead> <tbody> <tr> <td>3.125 GBaud</td> <td>00110011</td> <td>2.8 ps</td> <td>2.3 ps</td> </tr> <tr> <td>2.74 GBaud</td> <td>00110011</td> <td>2.9 ps</td> <td>2.4 ps</td> </tr> <tr> <td>2.35 GBaud</td> <td>00110011</td> <td>3.1 ps</td> <td>2.6 ps</td> </tr> <tr> <td>2.34 GBaud</td> <td>00110011</td> <td>3.1 ps</td> <td>2.6 ps</td> </tr> <tr> <td>1.95 GBaud</td> <td>00110011</td> <td>3.3 ps</td> <td>2.8 ps</td> </tr> <tr> <td>1.57 GBaud</td> <td>00110011</td> <td>3.6 ps</td> <td>3.1 ps</td> </tr> <tr> <td>100 Mbaud</td> <td>00110011</td> <td>27 ps</td> <td>27 ps</td> </tr> <tr> <td>10 Mbaud</td> <td>00110011</td> <td>252 ps</td> <td>252 ps</td> </tr> </tbody> </table>	Bit rate	Pattern	Jitter (ps rms)		PRBS	0011	3.125 GBaud	00110011	2.8 ps	2.3 ps	2.74 GBaud	00110011	2.9 ps	2.4 ps	2.35 GBaud	00110011	3.1 ps	2.6 ps	2.34 GBaud	00110011	3.1 ps	2.6 ps	1.95 GBaud	00110011	3.3 ps	2.8 ps	1.57 GBaud	00110011	3.6 ps	3.1 ps	100 Mbaud	00110011	27 ps	27 ps	10 Mbaud	00110011	252 ps	252 ps
Bit rate	Pattern			Jitter (ps rms)																																			
		PRBS	0011																																				
3.125 GBaud	00110011	2.8 ps	2.3 ps																																				
2.74 GBaud	00110011	2.9 ps	2.4 ps																																				
2.35 GBaud	00110011	3.1 ps	2.6 ps																																				
2.34 GBaud	00110011	3.1 ps	2.6 ps																																				
1.95 GBaud	00110011	3.3 ps	2.8 ps																																				
1.57 GBaud	00110011	3.6 ps	3.1 ps																																				
100 Mbaud	00110011	27 ps	27 ps																																				
10 Mbaud	00110011	252 ps	252 ps																																				
< 4 GHz models	20 ps rms + 1.25% Unit interval rms for PRBS data patterns. 20 ps rms + 1.25% Unit interval rms for repeating 0011 data patterns. (Transition density of 50%). Jitter increases by 1.4 every time the transition density is reduced by half. 28 ps rms + 1.25% Unit interval rms for 25% transition density. 30 ps rms + 1.25% Unit interval rms for 12.5% transition density.																																						
Serial trigger, serial word recognizer position accuracy	± 200 ps																																						
Clock recovery tracking/acquisition range, typical																																							
≥ 4 GHz models	± 2% of requested baud																																						
< 4 GHz models	± 5% of requested baud																																						

Table 1-4: Serial Trigger specifications (optional on < 4 GHz models DPO7000 Series) (Cont.)

Characteristic	Description
Minimum signal amplitude needed for clock recovery, typical	
\geq 4 GHz models	1 division p-p up to 1.25 GBd 1.5 divisions p-p above 1.25 GBd
< 4 GHz models	1 division p-p up to 1.25 GBd
Serial interface triggering standards supported, < 4 GHz models	IIC, CAN, SPI, USB1.0, RS232

Table 1-5: Input/output port specifications

Characteristic	Description	
Auxiliary Output logic polarity and functionality	Default output is main trigger low true (a negative edge when the main trigger event occurs). You can also program the output to main trigger high true, delay trigger low or high true, disabled, force high, and force low.	
Auxiliary Output logic levels, typical	$V_{out\ high}$	$V_{out\ low\ (true)}$
	$\geq 2.5\ V$ into $1\ M\Omega$ load, $\geq 1.0\ V$ into $50\ \Omega$ load to ground	$\leq 0.7\ V$ into $1\ M\Omega$ load, $\leq 0.25\ V$ into $50\ \Omega$ load to ground
CH3 output voltage, < 4 GHz models	50 mV/div $\pm 20\%$ into a $1\ M\Omega$ load 25 mV/div $\pm 20\%$ into a $50\ \Omega$ load	
Serial data output baud rate range, $\geq 4\ GHz$ models	Fbaud < 1250 MBd. Output swing of 1010 repeating pattern at this baud will be at least 200 mV into $50\ \Omega$.	
Serial clock output frequency range, $\geq 4\ GHz$ models	Peak-to-peak output swing at 625 MHz is at least 200 mV p-p into $50\ \Omega$. Higher frequencies are further attenuated by approximately 6 dB per octave above 625 MHz. Use AC or DC coupled $50\ \Omega$ termination; AC coupling the clock provides about 10% more amplitude.	
Serial data and clock output voltages, typical, $\geq 4\ GHz$ models	$V_{oh} = -1.0\ V$ $V_{ol} = -1.7\ V$ Assumes a load impedance greater than $1\ k\Omega$. ($50\ \Omega$ source termination.) If a $50\ \Omega$ or $75\ \Omega$ load is used, either use a DC blocking capacitor in series with the signal or reference the termination to about $-1.3\ V$. The signal amplitude will be correspondingly reduced.	
Serial data output latency, typical, $\geq 4\ GHz$ models	11 ns $\pm 4\ ns$ plus 35.5 clock cycles	
✓ Probe Compensation output step amplitude and offset		
$\geq 4\ GHz$ models	440 mV $\pm 20\%$ into a $50\ \Omega$ load ($V_{ol} = -140\ mV$, $V_{oh} = 0.3\ V$ typical) 810 mV $\pm 20\%$ into a $10\ k\Omega$ load ($V_{ol} = -0.25\ V$, $V_{oh} = 0.56\ mV$ typical)	
< 4 GHz models	1 V $\pm 1.5\%$ into a $\geq 100\ k\Omega$ load ($V_{ol} = -1.0\ V$, $V_{oh} = 0\ V$ typical) Add 0.05%/°C for temperatures greater than or less than $25\ ^\circ C$	
Probe Compensation output step frequency		
$\geq 4\ GHz$ models	1 kHz $\pm 20\%$	
< 4 GHz models	1 kHz $\pm 5\%$	
Probe Calibration output step rise time, typical		
< 4 GHz models	350 ps directly into an input channel. To deskew a probe, use a $50\ \Omega$ terminator in series with the deskew fixture to minimize HF aberrations.	
$\geq 4\ GHz$ models	300 ps directly into an input channel. To deskew a probe, use a $50\ \Omega$ terminator in series with the deskew fixture to minimize HF aberrations.	

Table 1-5: Input/output port specifications (Cont.)

Characteristic	Description	
Probe Calibration output step aberrations, typical	$\leq \pm 1\%$ after the first 500 ns following the square wave transition. To deskew a probe, use a 50 Ω terminator in series with the deskew fixture to minimize HF aberrations.	
Jitter of internal Probe Calibration trigger, typical	5 ps rms	
External reference, typical	Run SPC whenever the external reference is more than 0.2% (2000 ppm) different than the nominal reference or the reference at which SPC was last run. The timebase changes in correspondence to the fluctuations in the external reference.	
Input frequency	< 4 GHz models: 10 MHz \geq 4 GHz models: 10 MHz	
Input sensitivity	< 4 GHz models: $\geq 1.5 V_{p-p}$ \geq 4 GHz models: $\geq 200 mV_{p-p}$	
Input voltage, maximum	7 V_{p-p}	
Input impedance	< 4 GHz models: 385 Ω , $C_{in} = 137$ pF, measured at 10 MHz \geq 4 GHz models: 1.5 kohms, $C_{in} = 40$ pF, >100 kHz	
Input frequency variation tolerance	< 4 GHz models: 9.8 MHz to 10.2 MHz \geq 4 GHz models: Low jitter mode: ± 100 ppm Running SPC is required whenever the external reference is more than 0.2% (2000 ppm) different from the nominal reference frequency or reference at which SPC was last run.	
Internal reference output		
Frequency	< 4 GHz models: 10 MHz available at AUXOUT \geq 4 GHz models: 10 MHz	
Output voltage, typical	$V_{out\ high}$	$V_{out\ low\ (true)}$
< 4 GHz models	≥ 2.5 V into open circuit, ≥ 1.0 V into 50 Ω load to ground	≤ 0.7 V with ≤ 4 ma sink, ≤ 0.25 V into 50 Ω load to ground
\geq 4 GHz models	> 750 mV pk-pk into 50 Ω > 1.5 V pk-pk into 1 M Ω (internally AC coupled).	

Table 1-5: Input/output port specifications (Cont.)

Characteristic	Description
Input and output ports	
VGA Video output port	15 pin D-Sub female connector
Parallel port (IEEE 1284)	25 pin D-Sub connector, supports the following modes: standard (output only) bidirectional (PS-2 compatible) bidirectional enhanced parallel port (IEEE 1284 standard, mode 1 or mode 2, v 1.7) bidirectional high-speed extended capabilities port (ECP)
Serial port	9 pin D-Sub COM1 port, uses NS16C550-compatible UARTS, transfer speeds up to 115.2 kb/s
Keyboard and Mouse ports	PS-2 compatible, instrument must be powered down to make connection
LAN port	RJ-45 connector, supports 10 base-T, 100 base-T, and Gigabit Ethernet
External audio ports	External audio jacks for microphone input and line output
USB ports	Four rear panel and 1 front panel USB 2.0 connectors
GPIB port	IEEE 488.2 standard interface, listener or controller

Table 1-6: Data storage specifications

Characteristic	Description
Nonvolatile memory retention time, typical	> 20 years
Hard disk	Removeable hard disk drive, ≥ 80 GB capacity

Table 1-7: Power source specifications

Characteristic	Description
Power consumption	
≥ 4 GHz models	<1100 VA
< 4 GHz models	550 Watts maximum
Source voltage and frequency	
≥ 4 GHz models	100 to 240 V _{rms} , 50 Hz to 60 Hz 115 V $\pm 10\%$, 400 Hz
< 4 GHz models	100 V to 240 V _{rms} $\pm 10\%$, 47 Hz to 63 Hz 115 V $\pm 10\%$, 400 Hz
Value probe interface (VPI), < 4 GHz models	Probe interface allows installing, powering, compensating and controlling a wide range of probes offering a variety of features.

Table 1-8: Mechanical specifications

Characteristic	Description	
Weight		
< 4 GHz models Benchtop configuration	14.0 kg (31 lbs) instrument only	
	21.8 kg (48 lbs) when packaged for domestic shipment	
≥ 4 GHz models Benchtop configuration	20.0 kg (44 lbs) instrument only	
	34 kg (75 lbs) when packaged for domestic shipment	
Rackmount kit	2.04 kg (4.5 lbs) rackmount kit 3.4 kg (7.5 lbs) kit packaged for domestic shipment	
Dimensions		
< 4 GHz models Benchtop configuration	With front cover	Without front cover
	295.4 mm (11.6 in) height 468.6 mm (18.4 in) width 318 mm (12.5 in) depth	278 mm (10.95 in) height 450.8 mm (17.75 in) width 308.6 mm (12.15 in) depth
< 4 GHz models Rackmount configuration	311.15 mm (12.25 in) height 482.6 mm (19.0 in) width 520.7 mm (20.5 in) depth	
≥ 4 GHz models Benchtop configuration	With front cover	Without front cover
	278 mm (10.95 in) height 330 mm (13 in) with feet extended 451 mm (17.75 in) width 442 mm (17.4 in) depth	277 mm (10.9 in) height 330 mm (13 in) with feet extended 451 mm (17.75 in) width 432 mm (17.02 in) depth
≥ 4 GHz models Rackmount configuration	With rack handles	Without rack handles
	267 mm (10.5 in) height 502 mm (19.75 in) width 489 mm (19.4 in) depth	267 mm (10.5 in) height 482 mm (19 in) width 442 mm (17.4 in) depth
Cooling		
Fan-forced air circulation with no air filter		
Required clearances	Top	0 mm (0 in)
	Bottom	6.35 mm (0.25 in) minimum or 0 mm (0 in) when standing on feet, flip stands down
	Left side	76 mm (3 in)
	Right side	76 mm (3 in)
	Front	0 mm (0 in)
Construction material	Chassis parts are constructed of aluminum alloy, side and top panels are constructed of plastic laminate, circuit boards are constructed of glass laminate	

Certifications and Compliances

EC Declaration of Conformity - EMC

Meets intent of Directive 89/336/EEC for Electromagnetic Compatibility. Compliance was demonstrated to the following specifications as listed in the Official Journal of the European Communities:

EN 61326. EMC requirements for Class A electrical equipment for measurement, control, and laboratory use. Annex D.^{1,2,3}

- IEC 61000-4-2. Electrostatic discharge immunity
- IEC 61000-4-3. RF electromagnetic field immunity
- IEC 61000-4-4. Electrical fast transient / burst immunity
- IEC 61000-4-5. Power line surge immunity
- IEC 61000-4-6. Conducted RF Immunity
- IEC 61000-4-11. Voltage dips and interruptions immunity

EN 61000-3-2. AC power line harmonic emissions

EN 61000-3-3. Voltage changes, fluctuations, and flicker

- ¹ Emissions which exceed the levels required by this standard may occur when this equipment is connected to a test object.
- ² The performance criterion for when the oscilloscope is subjected to the continuously present electromagnetic phenomenon: 10 mV/division to 1 V/division: ≤ 0.4 division waveform displacement or ≤ 0.8 division increase in peak-to-peak noise
Performance criterion for when the oscilloscope is subjected to transient electromagnetic phenomenon: Temporary, self-recoverable degradation or loss of performance is allowed, but no change of actual operating state or loss of stored data is allowed.
- ³ If interconnect cables are used, they must be low-EMI shielded cables such as the following Tektronix part numbers or their equivalents: 012-0991-01, 012-0991-02 or 012-0991-03 GPIB Cable; 012-1213-00 (or CA part number 0294-9) RS-232 Cable; 012-1214-00 Centronics Cable; or LCOM part number CTL3VGAMM-5 VGA Cable. Use an 012-0482-00 cable for the Ref Out connector.

**Australia / New Zealand
Declaration of Conformity
- EMC**

Complies with EMC provision of Radiocommunications Act per these standard(s):

- AS/NZS 2064.1/2. Industrial, Scientific, and Medical Equipment: 1992

**EC Declaration of
Conformity - Low Voltage**

Compliance was demonstrated to the following specification as listed in the Official Journal of the European Communities:

Low Voltage Directive 73/23/EEC, amended by 93/68/EEC.

- EN 61010-1:2001. Safety requirements for electrical equipment for measurement control and laboratory use.

**U.S. Nationally
Recognized Testing
Laboratory Listing
Canadian Certification**

- UL 61010-1:2004, 2nd Edition. Standard for electrical measuring and test equipment.

- CAN/CSA C22.2 No. 61010-1:2004. Safety requirements for electrical equipment for measurement, control, and laboratory use. Part 1.

Additional Compliance

- IEC 61010-1:2001. Safety requirements for electrical equipment for measurement, control, and laboratory use.

Equipment Type

Test and measuring equipment.

Safety Class

Class 1 - grounded product

**Pollution Degree
Descriptions**

A measure of the contaminates that could occur in the environment around and within a product. Typically the internal environment inside a product is considered to be the same as the external. Products should be used only in the environment for which they are rated.

- Pollution Degree 1. No pollution or only dry, nonconductive pollution occurs. Products in this category are generally encapsulated, hermetically sealed, or located in clean rooms.
- Pollution Degree 2. Normally only dry, nonconductive pollution occurs. Occasionally a temporary conductivity that is caused by condensation must be expected. This location is a typical office/home environment. Temporary condensation occurs only when the product is out of service.
- Pollution Degree 3. Conductive pollution, or dry, nonconductive pollution that becomes conductive due to condensation. These are sheltered locations where neither temperature nor humidity is controlled. The area is protected from direct sunshine, rain, or direct wind.

- Pollution Degree 4. Pollution that generates persistent conductivity through conductive dust, rain, or snow. Typical outdoor locations.

Pollution Degree

Pollution Degree 2 (as defined in IEC 61010-1). Note: Rated for indoor use only.

**Installation (Overvoltage)
Category Descriptions**

Terminals on this product may have different installation (overvoltage) category designations. The installation categories are:

- Measurement Category IV. For measurements performed at the source of low-voltage installation.
- Measurement Category III. For measurements performed in the building installation.
- Measurement Category II. For measurements performed on circuits directly connected to the low-voltage installation.
- Measurement Category I. For measurements performed on circuits not directly connected to MAINS.

Overvoltage Category

Overvoltage Category II (as defined in IEC 61010-1)

Performance Verification

Two types of Performance Verification procedures can be performed on this product: *Brief Procedures* and *Performance Tests*. You may not need to perform all of these procedures, depending on what you want to accomplish.

- To rapidly confirm that the instrument functions and was adjusted properly, just do the brief procedures under *Self Tests*, which begin on page 2-5.

Advantages. These procedures are quick to do, require no external equipment or signal sources, and perform extensive functional and accuracy testing to provide high confidence that the instrument will perform properly. They can be used as a quick check before making a series of important measurements.

- To further check functionality, first do the *Self Tests* just mentioned; then do the brief procedures under *Functional Tests* that begin on page 2-6.

Advantages. These procedures require minimal additional time to perform, require no additional equipment other than cables and adapters, and these procedures more completely test the internal hardware of the instrument. They can be used to quickly determine if the instrument is suitable for putting into service, such as when it is first received.

- If more extensive confirmation of performance is desired, do the *Performance Tests*, beginning on page 2-15, after doing the *Functional* and *Self Tests* mentioned above.

Advantages. These procedures add direct checking of the warranted specifications that are marked with the ✓ symbol. These procedures require specific test equipment. (See *Table 2-2: Test equipment* on page 2-16).

If you are not familiar with operating this instrument, read the instrument user manual or explore the online help.

Conventions

Throughout these procedures the following conventions apply:

- Each test procedure uses the following general format:

Title of Test

Equipment Required

Prerequisites

Procedure

- Each procedure consists of as many steps, substeps, and subparts as required to do the test. Steps, substeps, and subparts are sequenced as follows:

1. First Step

- a. First Substep

- First Subpart

- Second Subpart

- b. Second Substep

2. Second Step

- In steps and substeps, the lead-in statement in italics instructs you what to do, while the instructions that follow tell you how to do it, as in the example step below:

Initialize the instrument: Push the front-panel **Default Setup** button.

STOP. *The **STOP** notation at the left is accompanied by information you must read to do the procedure properly.*

- The term “toolbar” refers to a row of buttons at the top of the display. The term “menu bar” refers to a row of menus at the top of the display. You can switch between toolbar and menu bar operating modes by using the menu at the top right of the toolbar or menu bar. See Figure 2-1.
- Item numbers in the equipment required lists refer to the equipment in Table 2-2 on page 2-16.



Figure 2-1: Toolbar and menu bar (< 4 GHz models shown)

- The procedures assume you have connected a mouse to the instrument so you can click on the screen controls. If you have not connected a mouse, you can use the touch screen to operate all the screen controls.

Brief Procedures

The *Self Tests* use internal routines to confirm basic functionality and proper adjustment. No test equipment is required to do these test procedures.

The *Functional Tests* utilize the probe-compensation output at the front panel as a test-signal source for further verifying that the instrument functions properly. A BNC cable and an adaptor or a probe, depending on your instrument model are required to do these test procedures.

Self Tests

This procedure uses internal routines to verify that the instrument functions and was adjusted properly. No test equipment or hookups are required.

Verify Internal Adjustment, Self Compensation, and Diagnostics

Equipment required	None
Prerequisites	Power on the instrument and allow a 20 minute warm-up before doing this procedure.

1. *Verify that internal diagnostics pass:* Do the following substeps to verify passing of internal diagnostics.
 - a. *Display the System diagnostics menu:*
 - If the instrument is in toolbar mode, put the instrument into menu bar mode.
 - Pull down the **Utilities** menu and select **Instrument Diagnostics. . . .** This displays the diagnostics control window.
 - b. *Run the System Diagnostics:*
 - First disconnect any input signals from all four channels.
 - Click the **Run** button in the diagnostics control window.
 - c. *Wait:* The internal diagnostics do an exhaustive verification of proper instrument function. This verification may take several minutes. When the verification is finished, the resulting status will appear in the diagnostics control window.
 - d. *Verify that no failures are found and reported on-screen.* All tests should pass.

- e. *Run the signal-path compensation routine:*
 - Pull down the **Utilities** menu and select **Instrument Calibration**. . . . This displays the instrument calibration control window.
 - If required because the instrument is in service mode, select the **Signal Path** button under Calibration Area.
 - Click the **Calibrate** button to start the routine.
 - f. *Wait:* Signal-path compensation may take five to fifteen minutes to run.
 - g. *Confirm signal-path compensation returns passed status:* Verify that the word **Pass** appears in the instrument calibration control window.
2. *Return to regular service:* Click the **X** (close) button to exit the instrument calibration control window.

Functional Tests

The purpose of these procedures is to confirm that the instrument functions properly. The only equipment required is a BNC or SMA cable and an adapter or the instrument probe. If you need to store settings during these procedures, access the local C: drive and store them in the TekScope > Setups directory.

STOP. *These procedures verify functions; that is, they verify that the instrument features operate. They do not verify that they operate within limits.*

Therefore, when the instructions in the functional tests that follow call for you to verify that a signal appears on-screen “that is about five divisions in amplitude” or “has a period of about six horizontal divisions,” etc., do NOT interpret the quantities given as limits. Operation within limits is checked in Performance Tests, which begin on page 2-15.

STOP. *DO NOT make changes to the front-panel settings that are not called out in the procedures. Each verification procedure will require you to set the instrument to certain default settings before verifying functions. If you make changes to these settings, other than those called out in the procedure, you may obtain invalid results. In this case, just redo the procedure from step 1.*

When you are instructed to press a front-panel or screen button, the button may already be selected (its label will be highlighted). If this is the case, it is not necessary to press the button.

Verify All Input Channels

Equipment required	<p>< 4 GHz models: One precision 50 Ω coaxial cable (Item 4)</p> <p>< 4 GHz models: One BNC to Minigrabber adapter (item 18)</p> <p>\geq 4 GHz models: One SMA cable (item 21)</p> <p>\geq 4 GHz models: One adapter (item 19)</p>
Prerequisites	None

1. *Initialize the instrument:* Push the front-panel **Default Setup** button.
2. *Hook up the signal source:* Connect the equipment as shown in Figure 2-2 to the channel input you want to test (beginning with Ch 1).

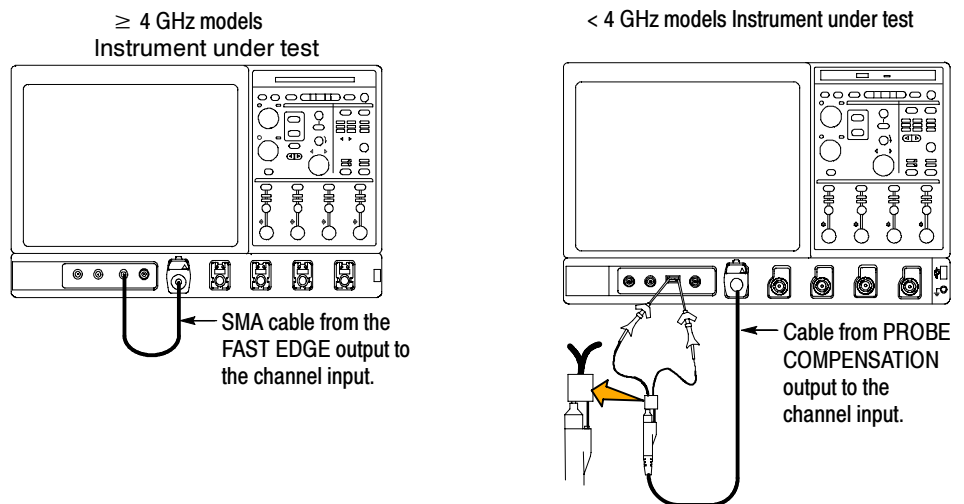

Figure 2-2: Universal test hookup for functional tests - Ch 1 shown

3. *Turn off all channels:* If any of the front-panel channel buttons are lighted, push those buttons to turn off the displayed channels. See Figure 2-3.

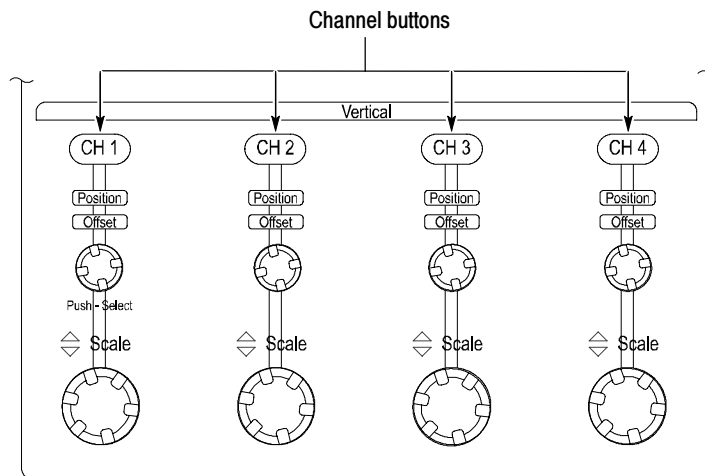

Figure 2- 3: Channel button location

4. *Select the channel to test:* Push the channel button for the channel you are currently testing. The button lights and the channel display comes on.
5. *Set up the instrument:*

NOTE. *If the AutoSet Undo window appears, click the X.*

- Push the front panel **Autoset** button. This sets the horizontal and vertical scale and vertical offset for a usable display and sets the trigger source to the channel you are testing.
 - Pull down the **Vertical** menu, select Vertical Setup. Confirm that the Ch1 Offset is about **0.0 mV**.
6. *Verify that the channel is operational:* Confirm that the following statements are true.
 - Verify that the vertical scale readout and the waveform amplitude for the channel under test are as shown in Table 2-1.

Table 2- 1: Vertical settings

Setting	< 4 GHz models	≥ 4 GHz models
	Without probe	Without probe
Scale	500 mV	100 mV
Waveform amplitude	2 divisions	4 divisions

- The front-panel vertical **Position** knob (for the channel you are testing) moves the signal up and down the screen when rotated.
 - Turning the vertical **Scale** knob counterclockwise (for the channel you are testing) decreases the amplitude of the waveform on-screen, turning the knob clockwise increases the amplitude, and returning the knob to the original scale setting returns the amplitude to that shown in Table 2-1 for that scale setting.
7. *Verify that the channel acquires in all acquisition modes:* Pull down the **Horiz/Acq** menu to select **Horizontal/Acquisition Setup**. . . . Click the **Acquisition** tab in the control window that displays. Click each of the acquisition modes and confirm that the following statements are true.
 - Sample mode displays an actively acquiring waveform on-screen. (Note that there is a small amount of noise present on the square wave).
 - Peak Detect mode displays an actively acquiring waveform on-screen with the noise present in Sample mode “peak detected.”
 - Hi Res mode displays an actively acquiring waveform on-screen with the noise that was present in Sample mode reduced.
 - Average mode displays an actively acquiring waveform on-screen with the noise reduced.
 - Envelope mode displays an actively acquiring waveform on-screen with the noise displayed.
 - Waveform Database mode displays an actively acquiring waveform on-screen with the noise displayed.
 8. *Test all channels:* Repeat steps 2 through 7 until all four input channels are verified.
 9. *Remove the test hookup:* Disconnect the equipment from the instrument.

Verify the Time Base

Equipment required	<p>< 4 GHz models: One precision 50 Ω coaxial cable (Item 4)</p> <p>< 4 GHz models: One BNC to Minigrabber adapter (item 18)</p> <p>\geq 4 GHz models: One SMA cable (item 21)</p> <p>\geq 4 GHz models: One adapter (item 19)</p>
Prerequisites	None

1. *Initialize the instrument:* Push the front-panel **Default Setup** button.
2. *Hook up the signal source:* Connect the probe compensation or fast edge output to the Ch 1 input as shown in Figure 2-4.

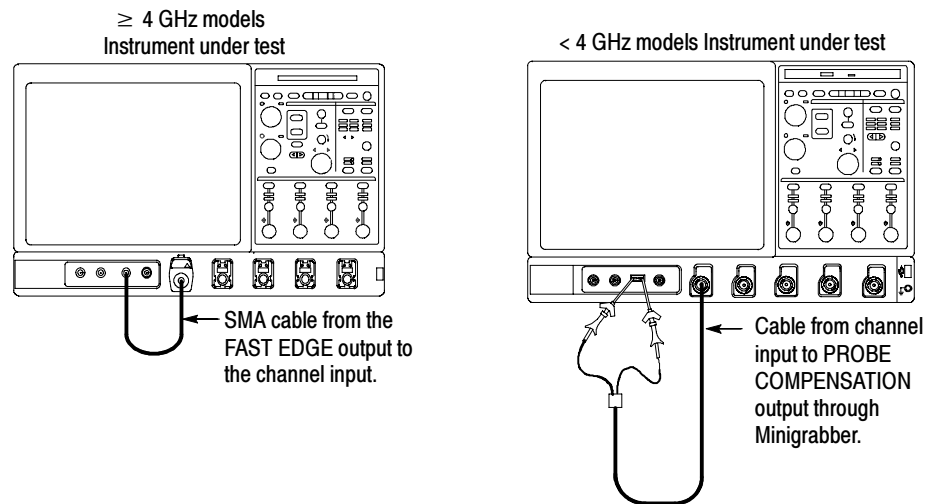

Figure 2- 4: Setup for time base test

3. *Set up the instrument:* Push the front panel **Autoset** button.
4. Set the **Vertical Scale** to **200 mV** per division.
5. *Set the time base:* Set the horizontal **Scale** to **200 $\mu\text{s}/\text{div}$** . The time-base readout is displayed at the bottom of the graticule.
6. *Verify that the time base operates:* Confirm the following statements.
 - One period of the square-wave signal is about five horizontal divisions on-screen for the 200 $\mu\text{s}/\text{div}$ horizontal scale setting.
 - Rotating the horizontal **Scale** knob clockwise expands the waveform on-screen (more horizontal divisions per waveform period), counter-clockwise rotation contracts it, and returning the horizontal scale to 200 $\mu\text{s}/\text{div}$ returns the period to about five divisions.
 - The horizontal **Position** knob positions the signal left and right on-screen when rotated.
7. *Verify horizontal delay:*
 - a. *Center a rising edge on screen:*
 - Set the horizontal **Position** knob so that the rising edge where the waveform is triggered is lined up with the center horizontal graticule.
 - Change the horizontal **Scale** to **20 $\mu\text{s}/\text{div}$** . The rising edge of the waveform should remain near the center graticule and the falling edge should be off screen.

- b. *Turn on and set horizontal delay:*
- Pull down the **Horiz/Acq** menu to select **Horizontal/Acquisition Setup. . . .**
 - Click the **Horizontal** tab in the control window that displays.
 - Click the **Delay Mode** button to turn delay on.
 - Double click the **Horiz Delay** control in the control window to display the pop-up keypad. Click the keypad buttons to set the horizontal delay to **1 ms** and then click the **ENTER** key.
- c. *Verify the waveform:* Verify that a rising edge of the waveform is within a few divisions of center screen.
- d. *Adjust the horizontal delay:* Rotate the upper multipurpose knob to change the horizontal delay setting. Verify that the rising edge shifts horizontally. Rotate the front-panel horizontal **Position** knob. Verify that this knob has the same effect (it also adjusts delay, but only when delay mode is on).
- e. *Verify the delay toggle function:*
- Rotate the front-panel horizontal **Position** knob to center the rising edge horizontally on the screen.
 - Change the horizontal **Scale** to **50 ns/div** (< 4 GHz models) or **40 ns/div** (\geq 4 GHz models). The rising edge of the waveform should remain near the center graticule.
 - Readjust the delay setting to position the rising edge 2 divisions to the right of the center graticule line.
 - Push the front-panel **Delay** button several times to toggle delay off and on and back off again. Verify that the display switches quickly between two different points in time (the rising edge shifts horizontally on the display).
8. *Remove the test hookup:* Disconnect the test hookup from the instrument.

Verify the A (Main) and B (Delayed) Trigger Systems

Equipment required	< 4 GHz models: One precision 50 Ω coaxial cable (Item 4) < 4 GHz models: One BNC to Minigrabber adapter (item 18) \geq 4 GHz models: One SMA cable (item 21) \geq 4 GHz models: One adapter (item 19)
Prerequisites	None

1. *Initialize the instrument:* Push the front-panel **Default Setup** button.

2. *Hook up the signal source:* Connect the probe compensation or fast edge output to the Ch 1 input as shown in Figure 2-5.

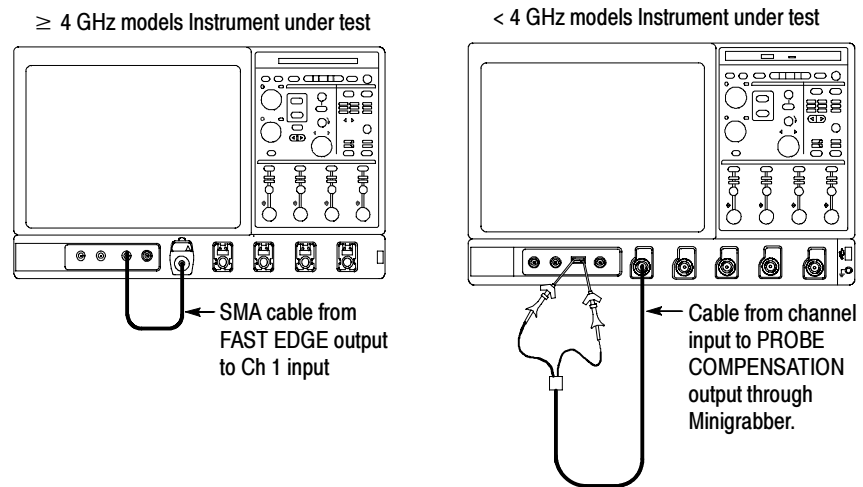

Figure 2-5: Setup for trigger test

3. *Set up the instrument:* Push the front-panel **Autoset** button.
4. Set the **Vertical Scale** to **200 mV** per division.
5. *Verify that the main trigger system operates:* Confirm that the following statements are true.
 - The trigger level readout for the A (main) trigger system changes with the trigger-**Level** knob.
 - The trigger-**Level** knob can trigger and untrigger the square-wave signal as you rotate it. (Leave the signal *untriggered*).
 - Pushing the front-panel trigger **Level** knob sets the trigger level to the 50% amplitude point of the signal and triggers the signal that you just left untriggered. (Leave the signal triggered.)

6. *Verify that the delayed trigger system operates:*
 - a. *Set up the delayed trigger:*
 - Pull down the **Trig** menu and select **A — B Trigger Sequence. . .**. This displays the A→B Sequence tab of the trigger setup control window.
 - Click the **Trig After Time** button under A Then B.
 - Click the **B Trig Level** control in the control window.
 - Set the front-panel trigger mode to **Norm**.
 - b. *Confirm that the following statements are true:*
 - The trigger-level readout for the B trigger system changes as you turn the lower multipurpose knob.
 - As you rotate the lower multipurpose knob, the square-wave signal can become triggered and untriggered. (Leave the signal triggered.)
 - c. *Verify the delayed trigger counter:*
 - Double click the **Trig Delay** control to pop up a numeric keypad for that control.
 - Click the keypad to enter a trigger delay time of **1 second** (click 1 and None) and then click **Enter**.
 - Verify that the trigger **Ready** indicator on the front panel flashes about once every second as the waveform is updated on-screen.
7. *Remove the test hookup:* Disconnect the test hookup from the instrument.

Verify the File System

Equipment required	<p>< 4 GHz models: One precision 50 Ω coaxial cable (Item 4)</p> <p>< 4 GHz models: One BNC to Minigrabber adapter (item 18)</p> <p>\geq 4 GHz models: One SMA cable (item 21)</p> <p>\geq 4 GHz models: One adapter (item 19)</p>
Prerequisites	None

1. *Initialize the instrument:* Push the front-panel **Default Setup** button.
2. *Hook up the signal source:* Connect the probe compensation or fast edge output to the Ch 1 input as shown in Figure 2-6.

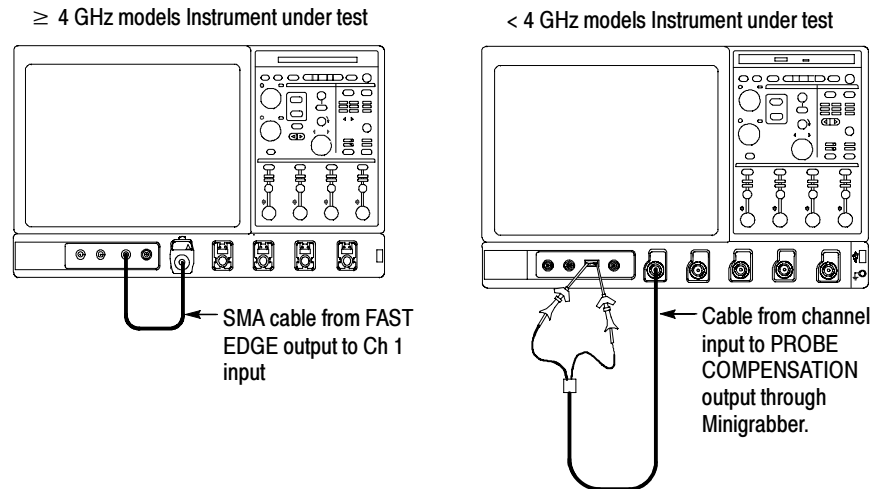

Figure 2-6: Setup for the file system test

3. *Set up the instrument:* Push the front panel **Autoset** button.
4. Set the **Vertical Scale** to **200 mV** per division.
5. *Set the time base:* Set the horizontal **Scale** to **1 ms/div**. The time-base readout is displayed at the bottom of the graticule.
6. *Save the settings:*
 - a. Pull down the **File** menu to select **Save As. . . >Setup. . .** This displays the instrument Save As control window.
 - b. Note the default location and file name and then click the **Save** button to save the setup to the default file name and location.
7. *Change the settings again:* Set the horizontal **SCALE** to **200 μ s/div**.
8. *Verify the file system works:*
 - a. Pull down the **File** menu to select **Recall**. This displays the instrument Recall control window.
 - b. Click Recall What > **Setup**.
 - c. Locate and then double click the setup file that you previously stored.
 - d. Verify that the instrument retrieved the saved setup. Do this by noticing the horizontal **SCALE** is again 1 ms and the waveform shows ten cycles just as it did when you saved the setup.
9. *Remove the test hookup:* Disconnect the test hookup from the instrument.

Performance Tests

This section contains a collection of manual procedures for checking that the instrument performs as warranted.

The procedures are arranged in logical groupings: *Signal Acquisition System Checks*, *Time Base System Checks*, *Triggering System Checks*, *Output Ports Checks*, and *Serial Trigger Checks*. They check all the characteristics that are designated as checked in *Specifications*. (The characteristics that are checked appear with a ✓ in *Specifications*).

STOP. *These procedures extend the confidence level provided by the basic procedures described on page 2-5. The basic procedures should be done first, then these procedures performed if desired.*

Prerequisites

The tests in this section comprise an extensive, valid confirmation of performance and functionality when the following requirements are met:

- The cabinet must be installed on the instrument.
- You must have performed and passed the procedures under *Self Tests*, found on page 2-5, and those under *Functional Tests*, found on page 2-6.
- A signal-path compensation must have been done within the recommended calibration interval and at a temperature within $\pm 5\text{ }^{\circ}\text{C}$ ($\pm 9\text{ }^{\circ}\text{F}$) of the present operating temperature. (If at the time you did the prerequisite *Self Tests*, the temperature was within the limits just stated, consider this prerequisite met). A signal-path compensation must have been done at an ambient humidity within 25% of the current ambient humidity and after having been at that humidity for at least 4 hours.
- The instrument must have been last adjusted at an ambient temperature between $+18\text{ }^{\circ}\text{C}$ ($+64\text{ }^{\circ}\text{F}$) and $+28\text{ }^{\circ}\text{C}$ ($+82\text{ }^{\circ}\text{F}$), must have been operating for a warm-up period of at least 20 minutes, and must be operating at an ambient temperature as listed in Table 1-9. (The warm-up requirement is usually met in the course of meeting the *Self Tests* and *Functional Tests* prerequisites listed above).
- Support sensor, probe, and adapter setups to avoid stress or torque when connected to the device under test (DUT).

Equipment Required

Procedures starting on page 2-37, use external, traceable signal sources to directly check warranted characteristics. Table 2-2 lists the required equipment.

Table 2-2: Test equipment

Item number and description	Minimum requirements	Example	Purpose
1. Attenuator, 10X (two required)	Ratio: 10X; impedance 50 Ω ; connectors: female input, male output	BNC \leq 2 GHz Tektronix part number 011-0059-03 SMA \leq 18 GHz Tektronix part number 015-1003-00	Signal attenuation, bandwidth, trigger sensitivity
2. Attenuator, 5X	Ratio: 5X; impedance 50 Ω ; connectors: female input, male output	BNC \leq 2 GHz Tektronix part number 011-0060-02 SMA \leq 18 GHz Tektronix part number 015-1002-01	Signal attenuation, bandwidth, trigger sensitivity
3. Termination, 50 Ω (three required)	Impedance 50 Ω ; connectors: female BNC input, male BNC output	Tektronix part number 011-0049-02 (1 GHz)	Signal termination for channel delay test, trigger sensitivity
4. Cable, Precision 50 Ω Coaxial (three required)	50 Ω , 36 in, male-to-male BNC connectors	Tektronix part number 012-0482-00	Signal interconnection, Trigger out, time qualified trigger, timebase delay time, baud rate limit, bandwidth, input resistance, delta time, clock recovery, generator leveling
5. Connector, Dual-Banana (two required)	Female BNC-to-dual banana	Tektronix part number 103-0090-00	Various accuracy tests, input resistance
6. Generator, DC Calibration	Variable amplitude to ± 7 V; accuracy to 0.1%	Fluke 9500B ¹	Checking DC offset, gain, measurement accuracy, probe compensation out, and maximum input voltage
7. Generator, Calibration	500 mV square wave calibrator amplitude; accuracy to 0.25%	Fluke 9500B ¹	To check accuracy of signal out, trigger out
8. Timer-counter	10 MHz and 100 MHz, 1 s gate	Advantest R5360	Checking long-term sample rate and delay time accuracy

Table 2-2: Test equipment (Cont.)

Item number and description	Minimum requirements	Example	Purpose
9. Generator, Sine-Wave	Instrument bandwidth \leq 3 GHz: 5 kHz to at least the instrument bandwidth. Variable amplitude from 60 mV to 2 V _{p-p} into 50 Ω . Frequency error <2.0%	Fluke 9500B ¹	Checking analog bandwidth, trigger sensitivity, sample-rate, external clock, trigger sensitivity, time qualified trigger, baud rate limit, clock recovery, and delay-time accuracy
	Instrument bandwidth > 3 GHz: 50 MHz to at least the instrument bandwidth. Variable amplitude from 60 mV to 2.0 V _{p-p} into 50 Ω . Frequency error <2.0%	Anritsu MG3692B or MG3694B Synthesized CW Generator with options 2x (step attenuator), 3 (low noise >2 GHz), 4 (10 MHz to 2 GHz low phase noise), 15 (high power), and 16 (high stability)	
10. Meter, Level and Power Sensor	Frequency range: 50 MHz to the instrument bandwidth. Amplitude range: 6 mV _{p-p} to 2 V _{p-p}	Rohde & Schwarz NRVS and NRV-Z15 (40 GHz)	Checking analog bandwidth and Trigger Sensitivity
11. Splitter, Power	Instrument bandwidth \leq 3 GHz: Frequency range: DC to 18 GHz. Tracking: < 2.0%	Agilent part number 11667A	Checking trigger sensitivity and analog bandwidth
	Instrument bandwidth > 3 GHz: Frequency range: DC to 40 GHz. Tracking: < 2.0%	Anritsu K241C (40 GHz)	
12. Cable	2.92 mm male-to-female	Gore PhaseFlex cable EL0CQ0CP0360 (40 GHz)	Checking analog bandwidth
13. Adapter	K male-to-male DC to 40 GHz	Anritsu K220B	Checking analog bandwidth
14. Adapter (four required)	Male N-to-female BNC	Tektronix part number 103-0045-00	Checking analog bandwidth
15. Adapter	Female N-to-male BNC	Tektronix part number 103-0058-00 (4 GHz)	Checking analog bandwidth
16. Adapter (three required)	SMA female-to-female	Tektronix part number 015-1012-00 (18 GHz)	Checking the delay between channels and trigger sensitivity
17. Adapter (three required)	SMA male-to-female BNC	Tektronix part number 015-1018-00	Checking the delay between channels, delta time
18. Adapter	BNC to Minigrabber	Tektronix part number 013-0342-xx	Checking probe compensation output
19. Adapter (four required)	SMA male-to-BNC female	TCA-BNC or TCA-292mm and, if required, SMA male-to-BNC female adapter (Tektronix part number 015-0554-00 (4 GHz) or 015-1018-00)	Signal interconnection, measurement accuracy, delay time, time qualified trigger, trigger sensitivity, DC gain, offset, bandwidth, input resistance, probe compensation out, baud rate limit, clock recovery

Table 2-2: Test equipment (Cont.)

Item number and description	Minimum requirements	Example	Purpose
20. Pulse Generator	250 MHz, ≤ 150 ps rise time, 5 V out	Fluke 9500B ^{1,2}	Used to test delta time measurement accuracy
21. Cable, Coaxial (three required)	50 Ω , 20 in, male-to-male SMA connectors	Tektronix part number 174-1427-00	Used to test delta time measurement accuracy, probe compensation out, trigger sensitivity
22. Adapter	SMA "T", male to 2 SMA female	Tektronix part number 015-1016-00 (18 GHz)	Used to test delta time measurement accuracy
23. Adapter	SMA female to BNC male	Tektronix part number 015-0572-00 (4 GHz)	Used to test delta time measurement accuracy and trigger sensitivity
24. Adapter	BNC male to female elbow	Tektronix part number 103-0031-00	Used to test delta time measurement accuracy
25. Termination	Short circuit, SMA connector, female	Tektronix part number 015-1021-00 (18 GHz)	Used to test delta time measurement accuracy
26. Attenuator, 2X	Ratio: 2X; impedance 50 Ω ; connectors: female BNC input, male BNC output	Tektronix part number 011-0069-02 (2 GHz)	Used to test delta time measurement accuracy, pulse trigger accuracy, time qualified trigger, trigger sensitivity, and channel isolation
27. Digital Multimeter	Ohms: <60 Ohms	Keithley 2000	Checking input impedance
28. Cable, coaxial	50 Ω , 39.37 in (1.0m), male-to-male SMA connectors 50 Ω , 60 in (1.5m), male-to-male SMA connectors	Tektronix part number 174-1341-00 Tektronix part number 174-1428-00	Checking analog bandwidth and delta time measurement accuracy. Checking ≥ 4 GHz models Serial Trigger Baud Rate Limits
29. Mouse or keyboard		Tektronix part numbers: 119-6298-xx (mouse) 119-6297-xx (keyboard)	Used to input test selections
30. Data Timing Generator	Data Timing Generator	Tektronix DTG5334 w/M31	Serial trigger baud rate limits

¹ Fluke 9500B/1100, 9500B/3200, or 9500B/2200 and an output head (9510 or 9530) appropriate for the bandwidth of the instrument being tested.

² For Delta Time Measurement Accuracy, use a Fluke 9500B or a pulse generator with a rise time as shown in Table 2-9 on page 2-70.

DPO7000 Series and DSA/DPO70000 Series Test Record

Photocopy this table and use it to record the performance test results for your instrument.

DPO7000, DPO70000 and DSA70000 Series Test Record

Instrument Serial Number: _____ Certificate Number: _____
 Temperature: _____ RH %: _____
 Date of Calibration: _____ Technician: _____

Instrument performance test		Minimum	Incoming	Outgoing	Maximum
DC voltage measurement accuracy (averaged), \geq 4 GHz models					
Ch1	10 mV Vert scale setting, -5 Div position setting, +0.45 V offset	+ 524.75 mV	_____	_____	+ 535.25 mV
Ch1	10 mV Vert scale setting, +5 Div position setting, -0.45 V offset	- 535.25 mV	_____	_____	- 524.75 mV
Ch1	20 mV Vert scale setting, -5 Div position setting, +0.4 V offset	+ 552.75 mV	_____	_____	+ 567.25 mV
Ch1	20 mV Vert scale setting, +5 Div position setting, -0.4 V offset	- 567.25 mV	_____	_____	- 552.75 mV
Ch1	50 mV Vert scale setting, -5 Div position setting, +0.25 V offset	+ 636.75 mV	_____	_____	+ 663.25 mV
Ch1	50 mV Vert scale setting, +5 Div position setting, -0.25 V offset	- 663.25 mV	_____	_____	- 636.75 mV
Ch1	100 mV Vert scale setting, -5 Div position setting, +4.5 V offset	+ 5.248 V	_____	_____	+ 5.353 V
Ch1	100 mV Vert scale setting, +5 Div position setting, -4.5 V offset	- 5.353 V	_____	_____	- 5.248 V
Ch1	200 mV Vert scale setting, -5 Div position setting, +4 V offset	+ 5.430 V	_____	_____	+ 5.571 V
Ch1	200 mV Vert scale setting, +5 Div position setting, -4 V offset	- 5.571 V	_____	_____	- 5.430 V
Ch1	500 mV Vert scale setting, -4 Div position setting, +2.5V offset	+ 5.379 V	_____	_____	+ 5.621 V
Ch1	500 mV Vert scale setting, +4 Div position setting, -2.5 V offset	- 5.621 V	_____	_____	- 5.379 V
Ch1	1.0 V Vert scale setting, -5 Div position setting, +0.0 V offset	+ 5.318 V	_____	_____	+ 5.683 V
Ch1	1.0 V Vert scale setting, +5 Div position setting, -0.0 V offset	- 5.683 V	_____	_____	- 5.318 V
Ch2	10 mV Vert scale setting, -5 Div position setting, +0.45 V offset	+ 524.75 mV	_____	_____	+ 535.25 mV
Ch2	10 mV Vert scale setting, +5 Div position setting, -0.45 V offset	- 535.25 mV	_____	_____	- 524.75 mV

DPO7000, DPO70000 and DSA70000 Series Test Record (cont.)

Instrument Serial Number: _____ Certificate Number: _____
 Temperature: _____ RH %: _____
 Date of Calibration: _____ Technician: _____

Instrument performance test		Minimum	Incoming	Outgoing	Maximum
Ch2	20 mV Vert scale setting, -5 Div position setting, +0.4 V offset	+ 552.75 mV	_____	_____	+ 567.25 mV
Ch2	20 mV Vert scale setting, +5 Div position setting, -0.4 V offset	- 567.25 mV	_____	_____	- 552.75 mV
Ch2	50 mV Vert scale setting, -5 Div position setting, +0.25 V offset	+ 636.75 mV	_____	_____	+ 663.25 mV
Ch2	50 mV Vert scale setting, +5 Div position setting, -0.25 V offset	- 663.25 mV	_____	_____	- 636.75 mV
Ch2	100 mV Vert scale setting, -5 Div position setting, +4.5 V offset	+ 5.248 V	_____	_____	+ 5.353 V
Ch2	100 mV Vert scale setting, +5 Div position setting, -4.5 V offset	- 5.353 V	_____	_____	- 5.248 V
Ch2	200 mV Vert scale setting, -5 Div position setting, +4 V offset	+ 5.430 V	_____	_____	+ 5.571 V
Ch2	200 mV Vert scale setting, +5 Div position setting, -4 V offset	- 5.571 V	_____	_____	- 5.430 V
Ch2	500 mV Vert scale setting, -4 Div position setting, +2.5V offset	+ 5.379 V	_____	_____	+ 5.621 V
Ch2	500 mV Vert scale setting, +4 Div position setting, -2.5 V offset	- 5.621 V	_____	_____	- 5.379 V
Ch2	1.0 V Vert scale setting, -5 Div position setting, +0.0 V offset	+ 5.318 V	_____	_____	+ 5.683 V
Ch2	1.0 V Vert scale setting, +5 Div position setting, -0.0 V offset	- 5.683 V	_____	_____	- 5.318 V
Ch3	10 mV Vert scale setting, -5 Div position setting, +0.45 V offset	+ 524.75 mV	_____	_____	+ 535.25 mV
Ch3	10 mV Vert scale setting, +5 Div position setting, -0.45 V offset	- 535.25 mV	_____	_____	- 524.75 mV
Ch3	20 mV Vert scale setting, -5 Div position setting, +0.4 V offset	+ 552.75 mV	_____	_____	+ 567.25 mV
Ch3	20 mV Vert scale setting, +5 Div position setting, -0.4 V offset	- 567.25 mV	_____	_____	- 552.75 mV
Ch3	50 mV Vert scale setting, -5 Div position setting, +0.25 V offset	+ 636.75 mV	_____	_____	+ 663.25 mV
Ch3	50 mV Vert scale setting, +5 Div position setting, -0.25 V offset	- 663.25 mV	_____	_____	- 636.75 mV
Ch3	100 mV Vert scale setting, -5 Div position setting, +4.5 V offset	+ 5.248 V	_____	_____	+ 5.353 V

DPO7000, DPO70000 and DSA70000 Series Test Record (cont.)

Instrument Serial Number: _____ Certificate Number: _____
 Temperature: _____ RH %: _____
 Date of Calibration: _____ Technician: _____

Instrument performance test		Minimum	Incoming	Outgoing	Maximum
Ch3	100 mV Vert scale setting, +5 Div position setting, -4.5 V offset	- 5.353 V	_____	_____	- 5.248 V
Ch3	200 mV Vert scale setting, -5 Div position setting, +4 V offset	+ 5.430 V	_____	_____	+ 5.571 V
Ch3	200 mV Vert scale setting, +5 Div position setting, -4 V offset	- 5.571 V	_____	_____	- 5.430 V
Ch3	500 mV Vert scale setting, -4 Div position setting, +2.5V offset	+ 5.379 V	_____	_____	+ 5.621 V
Ch3	500 mV Vert scale setting, +4 Div position setting, -2.5 V offset	- 5.621 V	_____	_____	- 5.379 V
Ch3	1.0 V Vert scale setting, -5 Div position setting, +0.0 V offset	+ 5.318 V	_____	_____	+ 5.683 V
Ch3	1.0 V Vert scale setting, +5 Div position setting, -0.0 V offset	- 5.683 V	_____	_____	- 5.318 V
Ch4	10 mV Vert scale setting, -5 Div position setting, +0.45 V offset	+ 524.75 mV	_____	_____	+ 535.25 mV
Ch4	10 mV Vert scale setting, +5 Div position setting, -0.45 V offset	- 535.25 mV	_____	_____	- 524.75 mV
Ch4	20 mV Vert scale setting, -5 Div position setting, +0.4 V offset	+ 552.75 mV	_____	_____	+ 567.25 mV
Ch4	20 mV Vert scale setting, +5 Div position setting, -0.4 V offset	- 567.25 mV	_____	_____	- 552.75 mV
Ch4	50 mV Vert scale setting, -5 Div position setting, +0.25 V offset	+ 636.75 mV	_____	_____	+ 663.25 mV
Ch4	50 mV Vert scale setting, +5 Div position setting, -0.25 V offset	- 663.25 mV	_____	_____	- 636.75 mV
Ch4	100 mV Vert scale setting, -5 Div position setting, +4.5 V offset	+ 5.248 V	_____	_____	+ 5.353 V
Ch4	100 mV Vert scale setting, +5 Div position setting, -4.5 V offset	- 5.353 V	_____	_____	- 5.248 V
Ch4	200 mV Vert scale setting, -5 Div position setting, +4 V offset	+ 5.430 V	_____	_____	+ 5.571 V
Ch4	200 mV Vert scale setting, +5 Div position setting, -4 V offset	- 5.571 V	_____	_____	- 5.430 V
Ch4	500 mV Vert scale setting, -4 Div position setting, +2.5V offset	+ 5.379 V	_____	_____	+ 5.621 V
Ch4	500 mV Vert scale setting, +4 Div position setting, -2.5 V offset	- 5.621 V	_____	_____	- 5.379 V

DPO7000, DPO70000 and DSA70000 Series Test Record (cont.)

Instrument Serial Number: _____ Certificate Number: _____
 Temperature: _____ RH %: _____
 Date of Calibration: _____ Technician: _____

Instrument performance test		Minimum	Incoming	Outgoing	Maximum
Ch4	1.0 V Vert scale setting, -5 Div position setting, +0.0 V offset	+ 5.318 V	_____	_____	+ 5.683 V
Ch4	1.0 V Vert scale setting, +5 Div position setting, -0.0 V offset	- 5.683 V	_____	_____	- 5.318 V
DC voltage measurement accuracy (averaged), < 4 GHz models					
Ch1	1 mV Vert scale setting, -5 Div position setting, +0.5 V offset	+ 504.25 mV	_____	_____	+ 509.76 mV
Ch1	1 mV Vert scale setting, +5 Div position setting, -0.5 V offset	- 509.76 mV	_____	_____	- 504.25 mV
Ch1	2 mV Vert scale setting, -5 Div position setting, +0.5 V offset	+ 513.0 mV	_____	_____	+ 519.03 mV
Ch1	2 mV Vert scale setting, +5 Div position setting, -0.5 V offset	- 519.03 mV	_____	_____	- 513.0 mV
Ch1	5 mV Vert scale setting, -5 Div position setting, +0.5 V offset	+ 536.3 mV	_____	_____	+ 543.7 mV
Ch1	5 mV Vert scale setting, +5 Div position setting, -0.5 V offset	- 543.7 mV	_____	_____	- 536.3 mV
Ch1	10 mV Vert scale setting, -5 Div position setting, +0.5 V offset	+ 574.28 mV	_____	_____	+ 585.73 mV
Ch1	10 mV Vert scale setting, +5 Div position setting, -0.5 V offset	- 585.73 mV	_____	_____	- 574.28 mV
Ch1	20 mV Vert scale setting, -5 Div position setting, +0.5 V offset	+ 651.8 mV	_____	_____	+ 668.2 mV
Ch1	20 mV Vert scale setting, +5 Div position setting, -0.5 V offset	- 668.2 mV	_____	_____	- 651.8 mV
Ch1	50 mV Vert scale setting, -5 Div position setting, +0.5 V offset	+ 884.38 mV	_____	_____	+ 915.63 mV
Ch1	50 mV Vert scale setting, +5 Div position setting, -0.5 V offset	- 915.63 V	_____	_____	- 884.38 mV
Ch1	90 mV Vert scale setting, -5 Div position setting, +0.5 V offset	+ 1.194 V	_____	_____	+ 1.246 V
Ch1	90 mV Vert scale setting, +5 Div position setting, -0.5 V offset	- 1.246 V	_____	_____	- 1.194 V
Ch1	100 mV Vert scale setting, 0 Div position setting, +4.5 V offset	+ 4.746 V	_____	_____	+ 4.854 V
Ch1	100 mV Vert scale setting, 0 Div position setting, -4.5 V offset	- 4.854 V	_____	_____	- 4.746 V

DPO7000, DPO70000 and DSA70000 Series Test Record (cont.)

Instrument Serial Number: _____ Certificate Number: _____
 Temperature: _____ RH %: _____
 Date of Calibration: _____ Technician: _____

Instrument performance test		Minimum	Incoming	Outgoing	Maximum
Ch1	200 mV Vert scale setting, -2 Div position setting, +4.6 V offset	+ 4.726 V	_____	_____	+ 4.875 V
Ch1	200 mV Vert scale setting, +2 Div position setting, -4.6 V offset	- 4.875 V	_____	_____	- 4.726 V
Ch1	500 mV Vert scale setting, -2 Div position setting, +5.0 V offset	+ 4.349 V	_____	_____	+ 4.651 V
Ch1	500 mV Vert scale setting, +2 Div position setting, -5.0 V offset	- 4.651 V	_____	_____	- 4.349 V
Ch1	1.0 V Vert scale setting, 0 Div position setting, +2.0 V offset	+ 4.748 V	_____	_____	+ 5.252 V
Ch1	1.0 V Vert scale setting, 0 Div position setting, -2.0 V offset	- 5.252 V	_____	_____	- 4.748 V
Ch2	1 mV Vert scale setting, -5 Div position setting, +0.5 V offset	+ 504.25 mV	_____	_____	+ 509.76 mV
Ch2	1 mV Vert scale setting, +5 Div position setting, -0.5 V offset	- 509.76 mV	_____	_____	- 504.25 mV
Ch2	2 mV Vert scale setting, -5 Div position setting, +0.5 V offset	+ 513.0 mV	_____	_____	+ 519.03 mV
Ch2	2 mV Vert scale setting, +5 Div position setting, -0.5 V offset	- 519.03 mV	_____	_____	- 513.0 mV
Ch2	5 mV Vert scale setting, -5 Div position setting, +0.5 V offset	+ 536.3 mV	_____	_____	+ 543.7 mV
Ch2	5 mV Vert scale setting, +5 Div position setting, -0.5 V offset	- 543.7 mV	_____	_____	- 536.3 mV
Ch2	10 mV Vert scale setting, -5 Div position setting, +0.5 V offset	+ 574.28 mV	_____	_____	+ 585.73 mV
Ch2	10 mV Vert scale setting, +5 Div position setting, -0.5 V offset	- 585.73 mV	_____	_____	- 574.28 mV
Ch2	20 mV Vert scale setting, -5 Div position setting, +0.5 V offset	+ 651.8 mV	_____	_____	+ 668.2 mV
Ch2	20 mV Vert scale setting, +5 Div position setting, -0.5 V offset	- 668.2 mV	_____	_____	- 651.8 mV
Ch2	50 mV Vert scale setting, -5 Div position setting, +0.5 V offset	+ 884.38 mV	_____	_____	+ 915.63 mV
Ch2	50 mV Vert scale setting, +5 Div position setting, -0.5 V offset	- 915.63 V	_____	_____	- 884.38 mV
Ch2	90 mV Vert scale setting, -5 Div position setting, +0.5 V offset	+ 1.194 V	_____	_____	+ 1.246 V

DPO7000, DPO70000 and DSA70000 Series Test Record (cont.)

Instrument Serial Number: _____ Certificate Number: _____
 Temperature: _____ RH %: _____
 Date of Calibration: _____ Technician: _____

Instrument performance test		Minimum	Incoming	Outgoing	Maximum
Ch2	90 mV Vert scale setting, +5 Div position setting, -0.5 V offset	- 1.246 V	_____	_____	- 1.194 V
Ch2	100 mV Vert scale setting, 0 Div position setting, +4.5 V offset	+ 4.746 V	_____	_____	+ 4.854 V
Ch2	100 mV Vert scale setting, 0 Div position setting, -4.5 V offset	- 4.854 V	_____	_____	- 4.746 V
Ch2	200 mV Vert scale setting, -2 Div position setting, +4.6 V offset	+ 4.726 V	_____	_____	+ 4.875 V
Ch2	200 mV Vert scale setting, +2 Div position setting, -4.6 V offset	- 4.875 V	_____	_____	- 4.726 V
Ch2	500 mV Vert scale setting, -2 Div position setting, +5.0 V offset	+ 4.349 V	_____	_____	+ 4.651 V
Ch2	500 mV Vert scale setting, +2 Div position setting, -5.0 V offset	- 4.651 V	_____	_____	- 4.349 V
Ch2	1.0 V Vert scale setting, 0 Div position setting, +2.0 V offset	+ 4.748 V	_____	_____	+ 5.252 V
Ch2	1.0 V Vert scale setting, 0 Div position setting, -2.0 V offset	- 5.252 V	_____	_____	- 4.748 V
Ch3	1 mV Vert scale setting, -5 Div position setting, +0.5 V offset	+ 504.25 mV	_____	_____	+ 509.76 mV
Ch3	1 mV Vert scale setting, +5 Div position setting, -0.5 V offset	- 509.76 mV	_____	_____	- 504.25 mV
Ch3	2 mV Vert scale setting, -5 Div position setting, +0.5 V offset	+ 513.0 mV	_____	_____	+ 519.03 mV
Ch3	2 mV Vert scale setting, +5 Div position setting, -0.5 V offset	- 519.03 mV	_____	_____	- 513.0 mV
Ch3	5 mV Vert scale setting, -5 Div position setting, +0.5 V offset	+ 536.3 mV	_____	_____	+ 543.7 mV
Ch3	5 mV Vert scale setting, +5 Div position setting, -0.5 V offset	- 543.7 mV	_____	_____	- 536.3 mV
Ch3	10 mV Vert scale setting, -5 Div position setting, +0.5 V offset	+ 574.28 mV	_____	_____	+ 585.73 mV
Ch3	10 mV Vert scale setting, +5 Div position setting, -0.5 V offset	- 585.73 mV	_____	_____	- 574.28 mV
Ch3	20 mV Vert scale setting, -5 Div position setting, +0.5 V offset	+ 651.8 mV	_____	_____	+ 668.2 mV
Ch3	20 mV Vert scale setting, +5 Div position setting, -0.5 V offset	- 668.2 mV	_____	_____	- 651.8 mV

DPO7000, DPO70000 and DSA70000 Series Test Record (cont.)

Instrument Serial Number: _____ Certificate Number: _____
 Temperature: _____ RH %: _____
 Date of Calibration: _____ Technician: _____

Instrument performance test		Minimum	Incoming	Outgoing	Maximum
Ch3	50 mV Vert scale setting, -5 Div position setting, +0.5 V offset	+ 884.38 mV	_____	_____	+ 915.63 mV
Ch3	50 mV Vert scale setting, +5 Div position setting, -0.5 V offset	- 915.63 V	_____	_____	- 884.38 mV
Ch3	90 mV Vert scale setting, -5 Div position setting, +0.5 V offset	+ 1.194 V	_____	_____	+ 1.246 V
Ch3	90 mV Vert scale setting, +5 Div position setting, -0.5 V offset	- 1.246 V	_____	_____	- 1.194 V
Ch3	100 mV Vert scale setting, 0 Div position setting, +4.5 V offset	+ 4.746 V	_____	_____	+ 4.854 V
Ch3	100 mV Vert scale setting, 0 Div position setting, -4.5 V offset	- 4.854 V	_____	_____	- 4.746 V
Ch3	200 mV Vert scale setting, -2 Div position setting, +4.6 V offset	+ 4.726 V	_____	_____	+ 4.875 V
Ch3	200 mV Vert scale setting, +2 Div position setting, -4.6 V offset	- 4.875 V	_____	_____	- 4.726 V
Ch3	500 mV Vert scale setting, -2 Div position setting, +5.0 V offset	+ 4.349 V	_____	_____	+ 4.651 V
Ch3	500 mV Vert scale setting, +2 Div position setting, -5.0 V offset	- 4.651 V	_____	_____	- 4.349 V
Ch3	1.0 V Vert scale setting, 0 Div position setting, +2.0 V offset	+ 4.748 V	_____	_____	+ 5.252 V
Ch3	1.0 V Vert scale setting, 0 Div position setting, -2.0 V offset	- 5.252 V	_____	_____	- 4.748 V
Ch4	1 mV Vert scale setting, -5 Div position setting, +0.5 V offset	+ 504.25 mV	_____	_____	+ 509.76 mV
Ch4	1 mV Vert scale setting, +5 Div position setting, -0.5 V offset	- 509.76 mV	_____	_____	- 504.25 mV
Ch4	2 mV Vert scale setting, -5 Div position setting, +0.5 V offset	+ 513.0 mV	_____	_____	+ 519.03 mV
Ch4	2 mV Vert scale setting, +5 Div position setting, -0.5 V offset	- 519.03 mV	_____	_____	- 513.0 mV
Ch4	5 mV Vert scale setting, -5 Div position setting, +0.5 V offset	+ 536.3 mV	_____	_____	+ 543.7 mV
Ch4	5 mV Vert scale setting, +5 Div position setting, -0.5 V offset	- 543.7 mV	_____	_____	- 536.3 mV
Ch4	10 mV Vert scale setting, -5 Div position setting, +0.5 V offset	+ 574.28 mV	_____	_____	+ 585.73 mV

DPO7000, DPO70000 and DSA70000 Series Test Record (cont.)

Instrument Serial Number: _____ Certificate Number: _____
 Temperature: _____ RH %: _____
 Date of Calibration: _____ Technician: _____

Instrument performance test		Minimum	Incoming	Outgoing	Maximum
Ch4	10 mV Vert scale setting, +5 Div position setting, -0.5 V offset	- 585.73 mV	_____	_____	- 574.28 mV
Ch4	20 mV Vert scale setting, -5 Div position setting, +0.5 V offset	+ 651.8 mV	_____	_____	+ 668.2 mV
Ch4	20 mV Vert scale setting, +5 Div position setting, -0.5 V offset	- 668.2 mV	_____	_____	- 651.8 mV
Ch4	50 mV Vert scale setting, -5 Div position setting, +0.5 V offset	+ 884.38 mV	_____	_____	+ 915.63 mV
Ch4	50 mV Vert scale setting, +5 Div position setting, -0.5 V offset	- 915.63 V	_____	_____	- 884.38 mV
Ch4	90 mV Vert scale setting, -5 Div position setting, +0.5 V offset	+ 1.194 V	_____	_____	+ 1.246 V
Ch4	90 mV Vert scale setting, +5 Div position setting, -0.5 V offset	- 1.246 V	_____	_____	- 1.194 V
Ch4	100 mV Vert scale setting, 0 Div position setting, +4.5 V offset	+ 4.746 V	_____	_____	+ 4.854 V
Ch4	100 mV Vert scale setting, 0 Div position setting, -4.5 V offset	- 4.854 V	_____	_____	- 4.746 V
Ch4	200 mV Vert scale setting, -2 Div position setting, +4.6 V offset	+ 4.726 V	_____	_____	+ 4.875 V
Ch4	200 mV Vert scale setting, +2 Div position setting, -4.6 V offset	- 4.875 V	_____	_____	- 4.726 V
Ch4	500 mV Vert scale setting, -2 Div position setting, +5.0 V offset	+ 4.349 V	_____	_____	+ 4.651 V
Ch4	500 mV Vert scale setting, +2 Div position setting, -5.0 V offset	- 4.651 V	_____	_____	- 4.349 V
Ch4	1.0 V Vert scale setting, 0 Div position setting, +2.0 V offset	+ 4.748 V	_____	_____	+ 5.252 V
Ch4	1.0 V Vert scale setting, 0 Div position setting, -2.0 V offset	- 5.252 V	_____	_____	- 4.748 V

DPO7000, DPO70000 and DSA70000 Series Test Record (cont.)

Instrument Serial Number: _____ Certificate Number: _____
 Temperature: _____ RH %: _____
 Date of Calibration: _____ Technician: _____

Instrument performance test		Minimum	Incoming	Outgoing	Maximum
DC gain accuracy (averaged), \geq 4 GHz models					
Ch1	10 mV Vert scale setting, 0 Div position setting, 0 V offset -5 Div position setting, +0.45 V offset +5 Div position setting, -0.45 V offset	+ 74.48 mV + 74.48 mV + 74.48 mV	_____ _____ _____	_____ _____ _____	+ 77.52 mV + 77.52 mV + 77.52 mV
Ch1	20 mV Vert scale setting, 0 Div position setting, 0 V offset -5 Div position setting, +0.4 V offset +5 Div position setting, -0.4 V offset	+ 148.96 mV + 148.96 mV + 148.96 mV	_____ _____ _____	_____ _____ _____	+ 155.04 mV + 155.04 mV + 155.04 mV
Ch1	50 mV Vert scale setting, 0 Div position setting, 0 V offset -5 Div position setting, +0.25 V offset +5 Div position setting, -0.25 V offset	+ 372.40 mV + 372.40 mV + 372.40 mV	_____ _____ _____	_____ _____ _____	+ 387.60 mV + 387.60 mV + 387.60 mV
Ch1	100 mV Vert scale setting, 0 Div position setting, 0 V offset -5 Div position setting, +4.5 V offset +5 Div position setting, -4.5 V offset	+ 744.80 mV + 744.80 mV + 744.80 mV	_____ _____ _____	_____ _____ _____	+ 775.20 mV + 775.20 mV + 775.20 mV
Ch1	200 mV Vert scale setting, 0 Div position setting, 0 V offset -5 Div position setting, +4.0 V offset +5 Div position setting, -4.0 V offset	+ 1.49 V + 1.235 V + 1.235 V	_____ _____ _____	_____ _____ _____	+ 1.550 V + 1.285 V + 1.285 V
Ch1	500 mV Vert scale setting, 0 Div position setting, 0 V offset -5 Div position setting, +2.5 V offset +5 Div position setting, -2.5 V offset	+ 3.724 V + 2.352 V + 2.352 V	_____ _____ _____	_____ _____ _____	+ 3.876 V + 2.448 V + 2.448 V
Ch1	1.0 V Vert scale setting, 0 Div position setting, 0 V offset -5 Div position setting, 0 V offset +5 Div position setting, 0 V offset	+ 7.448 V + 3.871 V + 3.871 V	_____ _____ _____	_____ _____ _____	+ 7.752 V + 4.029 V + 4.029 V
Ch2	10 mV Vert scale setting, 0 Div position setting, 0 V offset -5 Div position setting, +0.45 V offset +5 Div position setting, -0.45 V offset	+ 74.48 mV + 74.48 mV + 74.48 mV	_____ _____ _____	_____ _____ _____	+ 77.52 mV + 77.52 mV + 77.52 mV
Ch2	20 mV Vert scale setting, 0 Div position setting, 0 V offset -5 Div position setting, +0.4 V offset +5 Div position setting, -0.4 V offset	+ 148.96 mV + 148.96 mV + 148.96 mV	_____ _____ _____	_____ _____ _____	+ 155.04 mV + 155.04 mV + 155.04 mV

DPO7000, DPO70000 and DSA70000 Series Test Record (cont.)

Instrument Serial Number: _____ Certificate Number: _____
 Temperature: _____ RH %: _____
 Date of Calibration: _____ Technician: _____

Instrument performance test		Minimum	Incoming	Outgoing	Maximum
Ch2	50 mV Vert scale setting, 0 Div position setting, 0 V offset -5 Div position setting, +0.25 V offset +5 Div position setting, -0.25 V offset	+ 372.40 mV + 372.40 mV + 372.40 mV	_____ _____ _____	_____ _____ _____	+ 387.60 mV + 387.60 mV + 387.60 mV
Ch2	100 mV Vert scale setting, 0 Div position setting, 0 V offset -5 Div position setting, +4.5 V offset +5 Div position setting, -4.5 V offset	+ 744.80 mV + 744.80 mV + 744.80 mV	_____ _____ _____	_____ _____ _____	+ 775.20 mV + 775.20 mV + 775.20 mV
Ch2	200 mV Vert scale setting, 0 Div position setting, 0 V offset -5 Div position setting, +4.0 V offset +5 Div position setting, -4.0 V offset	+ 1.49 V + 1.235 V + 1.235 V	_____ _____ _____	_____ _____ _____	+ 1.550 V + 1.285 V + 1.285 V
Ch2	500 mV Vert scale setting, 0 Div position setting, 0 V offset -5 Div position setting, +2.5 V offset +5 Div position setting, -2.5 V offset	+ 3.724 V + 2.352 V + 2.352 V	_____ _____ _____	_____ _____ _____	+ 3.876 V + 2.448 V + 2.448 V
Ch2	1.0 V Vert scale setting, 0 Div position setting, 0 V offset -5 Div position setting, 0 V offset +5 Div position setting, 0 V offset	+ 7.448 V + 3.871 V + 3.871 V	_____ _____ _____	_____ _____ _____	+ 7.752 V + 4.029 V + 4.029 V
Ch3	10 mV Vert scale setting, 0 Div position setting, 0 V offset -5 Div position setting, +0.45 V offset +5 Div position setting, -0.45 V offset	+ 74.48 mV + 74.48 mV + 74.48 mV	_____ _____ _____	_____ _____ _____	+ 77.52 mV + 77.52 mV + 77.52 mV
Ch3	20 mV Vert scale setting, 0 Div position setting, 0 V offset -5 Div position setting, +0.4 V offset +5 Div position setting, -0.4 V offset	+ 148.96 mV + 148.96 mV + 148.96 mV	_____ _____ _____	_____ _____ _____	+ 155.04 mV + 155.04 mV + 155.04 mV
Ch3	50 mV Vert scale setting, 0 Div position setting, 0 V offset -5 Div position setting, +0.25 V offset +5 Div position setting, -0.25 V offset	+ 372.40 mV + 372.40 mV + 372.40 mV	_____ _____ _____	_____ _____ _____	+ 387.60 mV + 387.60 mV + 387.60 mV
Ch3	100 mV Vert scale setting, 0 Div position setting, 0 V offset -5 Div position setting, +4.5 V offset +5 Div position setting, -4.5 V offset	+ 744.80 mV + 744.80 mV + 744.80 mV	_____ _____ _____	_____ _____ _____	+ 775.20 mV + 775.20 mV + 775.20 mV
Ch3	200 mV Vert scale setting, 0 Div position setting, 0 V offset -5 Div position setting, +4.0 V offset +5 Div position setting, -4.0 V offset	+ 1.49 V + 1.235 V + 1.235 V	_____ _____ _____	_____ _____ _____	+ 1.550 V + 1.285 V + 1.285 V

DPO7000, DPO70000 and DSA70000 Series Test Record (cont.)

Instrument Serial Number: _____ Certificate Number: _____
 Temperature: _____ RH %: _____
 Date of Calibration: _____ Technician: _____

Instrument performance test		Minimum	Incoming	Outgoing	Maximum
Ch3	500 mV Vert scale setting, 0 Div position setting, 0 V offset -5 Div position setting, +2.5 V offset +5 Div position setting, -2.5 V offset	+ 3.724 V + 2.352 V + 2.352 V	_____ _____ _____	_____ _____ _____	+ 3.876 V + 2.448 V + 2.448 V
Ch3	1.0 V Vert scale setting, 0 Div position setting, 0 V offset -5 Div position setting, 0 V offset +5 Div position setting, 0 V offset	+ 7.448 V + 3.871 V + 3.871 V	_____ _____ _____	_____ _____ _____	+ 7.752 V + 4.029 V + 4.029 V
Ch4	10 mV Vert scale setting, 0 Div position setting, 0 V offset -5 Div position setting, +0.45 V offset +5 Div position setting, -0.45 V offset	+ 74.48 mV + 74.48 mV + 74.48 mV	_____ _____ _____	_____ _____ _____	+ 77.52 mV + 77.52 mV + 77.52 mV
Ch4	20 mV Vert scale setting, 0 Div position setting, 0 V offset -5 Div position setting, +0.4 V offset +5 Div position setting, -0.4 V offset	+ 148.96 mV + 148.96 mV + 148.96 mV	_____ _____ _____	_____ _____ _____	+ 155.04 mV + 155.04 mV + 155.04 mV
Ch4	50 mV Vert scale setting, 0 Div position setting, 0 V offset -5 Div position setting, +0.25 V offset +5 Div position setting, -0.25 V offset	+ 372.40 mV + 372.40 mV + 372.40 mV	_____ _____ _____	_____ _____ _____	+ 387.60 mV + 387.60 mV + 387.60 mV
Ch4	100 mV Vert scale setting, 0 Div position setting, 0 V offset -5 Div position setting, +4.5 V offset +5 Div position setting, -4.5 V offset	+ 744.80 mV + 744.80 mV + 744.80 mV	_____ _____ _____	_____ _____ _____	+ 775.20 mV + 775.20 mV + 775.20 mV
Ch4	200 mV Vert scale setting, 0 Div position setting, 0 V offset -5 Div position setting, +4.0 V offset +5 Div position setting, -4.0 V offset	+ 1.49 V + 1.235 V + 1.235 V	_____ _____ _____	_____ _____ _____	+ 1.550 V + 1.285 V + 1.285 V
Ch4	500 mV Vert scale setting, 0 Div position setting, 0 V offset -5 Div position setting, +2.5 V offset +5 Div position setting, -2.5 V offset	+ 3.724 V + 2.352 V + 2.352 V	_____ _____ _____	_____ _____ _____	+ 3.876 V + 2.448 V + 2.448 V
Ch4	1.0 V Vert scale setting, 0 Div position setting, 0 V offset -5 Div position setting, 0 V offset +5 Div position setting, 0 V offset	+ 7.448 V + 3.871 V + 3.871 V	_____ _____ _____	_____ _____ _____	+ 7.752 V + 4.029 V + 4.029 V

DPO7000, DPO70000 and DSA70000 Series Test Record (cont.)

Instrument Serial Number: _____ Certificate Number: _____
 Temperature: _____ RH %: _____
 Date of Calibration: _____ Technician: _____

Instrument performance test		Minimum	Incoming	Outgoing	Maximum
Offset accuracy, \geq 4 GHz models					
Ch1	10 mV Vert scale setting, -5 Div position setting, +0.45 V offset 5 Div position setting, -0.45 V offset	+ 495.75 mV - 504.25 mV	_____	_____	+ 504.25 mV - 495.75 mV
Ch1	20 mV Vert scale setting, -5 Div position setting, +0.4 V offset 5 Div position setting, -0.4 V offset	+ 494.75 mV - 505.25 mV	_____	_____	+ 505.25 mV - 494.75 mV
Ch1	50 mV Vert scale setting, -5 Div position setting, +0.25 V offset 5 Div position setting, -0.25 V offset	+ 491.75 mV - 508.25 mV	_____	_____	+ 508.25 mV - 491.75 mV
Ch1	100 mV Vert scale setting, -5 Div position setting, +4.5 V offset 5 Div position setting, -4.5 V offset	+ 4.958 V - 5.043 V	_____	_____	+ 5.043 V - 4.958 V
Ch1	200 mV Vert scale setting, -5 Div position setting, +2 V offset 5 Div position setting, -2 V offset	+ 2.955 V - 3.046 V	_____	_____	+ 3.046 V - 2.955 V
Ch1	500 mV Vert scale setting, -5 Div position setting, +2.5 V offset 5 Div position setting, -2.5 V offset	+ 4.918 V - 5.083 V	_____	_____	+ 5.083 V - 4.918 V
Ch1	1.0 V Vert scale setting, -5 Div position setting, 0 V offset 5 Div position setting, 0 V offset	+ 2.368 V - 2.633 V	_____	_____	+ 2.633 V - 2.368 V
Ch2	10 mV Vert scale setting, -5 Div position setting, +0.45 V offset 5 Div position setting, -0.45 V offset	+ 495.75 mV - 504.25 mV	_____	_____	+ 504.25 mV - 495.75 mV
Ch2	20 mV Vert scale setting, -5 Div position setting, +0.4 V offset 5 Div position setting, -0.4 V offset	+ 494.75 mV - 505.25 mV	_____	_____	+ 505.25 mV - 494.75 mV
Ch2	50 mV Vert scale setting, -5 Div position setting, +0.25 V offset 5 Div position setting, -0.25 V offset	+ 491.75 mV - 508.25 mV	_____	_____	+ 508.25 mV - 491.75 mV
Ch2	100 mV Vert scale setting, -5 Div position setting, +4.5 V offset 5 Div position setting, -4.5 V offset	+ 4.958 V - 5.043 V	_____	_____	+ 5.043 V - 4.958 V
Ch2	200 mV Vert scale setting, -5 Div position setting, +2 V offset 5 Div position setting, -2 V offset	+ 2.955 V - 3.046 V	_____	_____	+ 3.046 V - 2.955 V
Ch2	500 mV Vert scale setting, -5 Div position setting, +2.5 V offset 5 Div position setting, -2.5 V offset	+ 4.918 V - 5.083 V	_____	_____	+ 5.083 V - 4.918 V

DPO7000, DPO70000 and DSA70000 Series Test Record (cont.)

Instrument Serial Number: _____ Certificate Number: _____
 Temperature: _____ RH %: _____
 Date of Calibration: _____ Technician: _____

Instrument performance test		Minimum	Incoming	Outgoing	Maximum
Ch2	1.0 V Vert scale setting, -5 Div position setting, 0 V offset 5 Div position setting, 0 V offset	+ 2.368 V - 2.633 V	_____	_____	+ 2.633 V - 2.368 V
Ch3	10 mV Vert scale setting, -5 Div position setting, +0.45 V offset 5 Div position setting, -0.45 V offset	+ 495.75 mV - 504.25 mV	_____	_____	+ 504.25 mV - 495.75 mV
Ch3	20 mV Vert scale setting, -5 Div position setting, +0.4 V offset 5 Div position setting, -0.4 V offset	+ 494.75 mV - 505.25 mV	_____	_____	+ 505.25 mV - 494.75 mV
Ch3	50 mV Vert scale setting, -5 Div position setting, +0.25 V offset 5 Div position setting, -0.25 V offset	+ 491.75 mV - 508.25 mV	_____	_____	+ 508.25 mV - 491.75 mV
Ch3	100 mV Vert scale setting, -5 Div position setting, +4.5 V offset 5 Div position setting, -4.5 V offset	+ 4.958 V - 5.043 V	_____	_____	+ 5.043 V - 4.958 V
Ch3	200 mV Vert scale setting, -5 Div position setting, +2 V offset 5 Div position setting, -2 V offset	+ 2.955 V - 3.046 V	_____	_____	+ 3.046 V - 2.955 V
Ch3	500 mV Vert scale setting, -5 Div position setting, +2.5 V offset 5 Div position setting, -2.5 V offset	+ 4.918 V - 5.083 V	_____	_____	+ 5.083 V - 4.918 V
Ch3	1.0 V Vert scale setting, -5 Div position setting, 0 V offset 5 Div position setting, 0 V offset	+ 2.368 V - 2.633 V	_____	_____	+ 2.633 V - 2.368 V
Ch4	10 mV Vert scale setting, -5 Div position setting, +0.45 V offset 5 Div position setting, -0.45 V offset	+ 495.75 mV - 504.25 mV	_____	_____	+ 504.25 mV - 495.75 mV
Ch4	20 mV Vert scale setting, -5 Div position setting, +0.4 V offset 5 Div position setting, -0.4 V offset	+ 494.75 mV - 505.25 mV	_____	_____	+ 505.25 mV - 494.75 mV
Ch4	50 mV Vert scale setting, -5 Div position setting, +0.25 V offset 5 Div position setting, -0.25 V offset	+ 491.75 mV - 508.25 mV	_____	_____	+ 508.25 mV - 491.75 mV
Ch4	100 mV Vert scale setting, -5 Div position setting, +4.5 V offset 5 Div position setting, -4.5 V offset	+ 4.958 V - 5.043 V	_____	_____	+ 5.043 V - 4.958 V
Ch4	200 mV Vert scale setting, -5 Div position setting, +2 V offset 5 Div position setting, -2 V offset	+ 2.955 V - 3.046 V	_____	_____	+ 3.046 V - 2.955 V

Performance Tests

DPO7000, DPO70000 and DSA70000 Series Test Record (cont.)

Instrument Serial Number: _____ Certificate Number: _____
 Temperature: _____ RH %: _____
 Date of Calibration: _____ Technician: _____

Instrument performance test		Minimum	Incoming	Outgoing	Maximum
Ch4	500 mV Vert scale setting, -5 Div position setting, +2.5 V offset 5 Div position setting, -2.5 V offset	+ 4.918 V - 5.083 V	_____ _____	_____ _____	+ 5.083 V - 4.918 V
Ch4	1.0 V Vert scale setting, -5 Div position setting, 0 V offset 5 Div position setting, 0 V offset	+ 2.368 V - 2.633 V	_____ _____	_____ _____	+ 2.633 V - 2.368 V

Analog bandwidth

Ch1	1 V	3.535 V	_____	_____	N/A
	500 mV	2.12 V	_____	_____	N/A
	200 mV	848 mV	_____	_____	N/A
	100 mV	424 mV	_____	_____	N/A
	50 mV	212 mV	_____	_____	N/A
	20 mV	84.8 mV	_____	_____	N/A
	10 mV	42.4 mV	_____	_____	N/A
	< 4 GHz models: 5 mV	21.2 mV	_____	_____	N/A
	< 4 GHz models: 2 mV	8.48 mV	_____	_____	N/A
	< 4 GHz models: 1 mV	4.24 mV	_____	_____	N/A
Ch2	1 V	3.535 V	_____	_____	N/A
	500 mV	2.12 V	_____	_____	N/A
	200 mV	848 V	_____	_____	N/A
	100 mV	424 mV	_____	_____	N/A
	50 mV	212 mV	_____	_____	N/A
	20 mV	84.8 mV	_____	_____	N/A
	10 mV	42.4 mV	_____	_____	N/A
	< 4 GHz models: 5 mV	21.2 mV	_____	_____	N/A
	< 4 GHz models: 2 mV	8.48 mV	_____	_____	N/A
	< 4 GHz models: 1 mV	4.24 mV	_____	_____	N/A
Ch3	1 V	3.535 V	_____	_____	N/A
	500 mV	2.12 V	_____	_____	N/A
	200 mV	848 V	_____	_____	N/A
	100 mV	424 mV	_____	_____	N/A
	50 mV	212 mV	_____	_____	N/A
	20 mV	84.8 mV	_____	_____	N/A
	10 mV	42.4 mV	_____	_____	N/A
	< 4 GHz models: 5 mV	21.2 mV	_____	_____	N/A
	< 4 GHz models: 2 mV	8.48 mV	_____	_____	N/A
	< 4 GHz models: 1 mV	4.24 mV	_____	_____	N/A

DPO7000, DPO70000 and DSA70000 Series Test Record (cont.)

Instrument Serial Number: _____ Certificate Number: _____
 Temperature: _____ RH %: _____
 Date of Calibration: _____ Technician: _____

Instrument performance test		Minimum	Incoming	Outgoing	Maximum
Ch4	1 V	3.535 V	_____	_____	N/A
	500 mV	2.12 V	_____	_____	N/A
	200 mV	848 V	_____	_____	N/A
	100 mV	424 mV	_____	_____	N/A
	50 mV	212 mV	_____	_____	N/A
	20 mV	84.8 mV	_____	_____	N/A
	10 mV	42.4 mV	_____	_____	N/A
	< 4 GHz models: 5 mV	21.2 mV	_____	_____	N/A
	< 4 GHz models: 2 mV	8.48 mV	_____	_____	N/A
	< 4 GHz models: 1 mV	4.24 mV	_____	_____	N/A
Input resistance, \geq 4 GHz models					
	Ch1 10 mV	49.25 Ω	_____	_____	50.75 Ω
	Ch1 100 mV	49.25 Ω	_____	_____	50.75 Ω
	Ch2 10 mV	49.25 Ω	_____	_____	50.75 Ω
	Ch2 100 mV	49.25 Ω	_____	_____	50.75 Ω
	Ch3 10 mV	49.25 Ω	_____	_____	50.75 Ω
	Ch3 100 mV	49.25 Ω	_____	_____	50.75 Ω
	Ch4 10 mV	49.25 Ω	_____	_____	50.75 Ω
	Ch4 100 mV	49.25 Ω	_____	_____	50.75 Ω
Time base system					
Long term sample rate, delay time, and internal reference accuracy					
	10 MHz, < 4 GHz models	9999.965 kHz	_____	_____	10000.035 kHz
	10 MHz, \geq 4 GHz models	9999.975 kHz	_____	_____	10000.025 kHz
External reference					
	10 MHz	Pass/Fail	_____	_____	Pass/Fail
	100 MHz, \geq 4 GHz models	Pass/Fail	_____	_____	Pass/Fail
Delta time measurement					
	DPO7054:	N/A	_____	_____	\leq 6.0 ps
		N/A	_____	_____	\leq 12.0 ps
Trigger system accuracy					
Time accuracy for time qualified triggers, < 4 GHz models, time range < 1 μ s					
	Lower Limit	3.5 ns	_____	_____	6.5 ns
	Upper Limit	3.5 ns	_____	_____	6.5 ns
time range \geq 1 μ s					
	Lower Limit	1.9 μ s	_____	_____	2.1 μ s
	Upper Limit	1.9 μ s	_____	_____	2.1 μ s

Performance Tests

DPO7000, DPO70000 and DSA70000 Series Test Record (cont.)

Instrument Serial Number: _____ Certificate Number: _____
 Temperature: _____ RH %: _____
 Date of Calibration: _____ Technician: _____

Instrument performance test	Minimum	Incoming	Outgoing	Maximum
Time accuracy for time qualified triggers, ≥ 4 GHz models, time range < 1 μs				
Lower Limit	4.77 ns	_____	_____	5.23 ns
Upper Limit	4.77 ns	_____	_____	5.23 ns
time range ≥ 1 μs				
Lower Limit	1.9 μs	_____	_____	2.1 μs
Upper Limit	1.9 μs	_____	_____	2.1 μs
Ch1 trigger sensitivity, 50 MHz	Pass/Fail	_____	_____	Pass/Fail
Ch1 delayed trigger sensitivity ≥ 4 GHz models: 50 MHz	Pass/Fail	_____	_____	Pass/Fail
AUX trigger input sensitivity, 50 MHz	Pass/Fail	_____	_____	Pass/Fail
Ch1 trigger sensitivity < 4 GHz models:	Pass/Fail	_____	_____	Pass/Fail
≥ 4 GHz models: 4 GHz	Pass/Fail	_____	_____	Pass/Fail
≥ 4 GHz models: 6 GHz	Pass/Fail	_____	_____	Pass/Fail
≥ 4 GHz models: 8 GHz	Pass/Fail	_____	_____	Pass/Fail
≥ 4 GHz models: 11 GHz	Pass/Fail	_____	_____	Pass/Fail
Ch1 B trigger sensitivity				
≥ 4 GHz models: 4 GHz	Pass/Fail	_____	_____	Pass/Fail
≥ 4 GHz models: 6 GHz	Pass/Fail	_____	_____	Pass/Fail
≥ 4 GHz models: 8 GHz	Pass/Fail	_____	_____	Pass/Fail
≥ 4 GHz models: 9 GHz	Pass/Fail	_____	_____	Pass/Fail
Ch1 AUX trigger input				
< 4 GHz models: 250 MHz	Pass/Fail	_____	_____	Pass/Fail
≥ 4 GHz models: 1 GHz	Pass/Fail	_____	_____	Pass/Fail
Aux trigger out				
Vout Hi	1.0 V	_____	_____	
Vout Lo		_____	_____	0.25 V
Probe compensation output signal				
Voltage (difference)				
< 4 GHz models	985 mV	_____	_____	1015 mV
≥ 4 GHz models	352 mV	_____	_____	528 mV

DPO7000, DPO70000 and DSA70000 Series Test Record (cont.)

Instrument Serial Number: _____ Certificate Number: _____
 Temperature: _____ RH %: _____
 Date of Calibration: _____ Technician: _____

Instrument performance test	Minimum	Incoming	Outgoing	Maximum
Serial trigger (\geq 4 GHz models with Option PTH or $<$ 4 GHz models with Option PTM only)				
Baud rate limits				
Serial word recognizer				
Signal path 0, Pattern matching 1				
Trigger 1 UI before 0	Pass	_____	_____	N/A
Trigger on 0	Pass	_____	_____	N/A
Trigger 1 UI after 0	Pass	_____	_____	N/A
Signal path 1, Pattern matching 1				
Trigger 1 UI before 1	Pass	_____	_____	N/A
Trigger on 1	Pass	_____	_____	N/A
Trigger 1 UI after 1	Pass	_____	_____	N/A
Baud rate limits $>$ 1.25Gbaud, \geq 4 GHz models	Pass	_____	_____	N/A
Clock recovery frequency range	Pass	_____	_____	N/A

Signal Acquisition System Checks

These procedures check those characteristics that relate to the signal-acquisition system and are listed as checked under *Warranted Characteristics* in *Specifications*. Refer to Table 2-2 on page 2-16 for test equipment specifications.

Check DC Voltage Measurement Accuracy

Equipment required	One DC calibration generator (Item 6) One SMA male-to-BNC female adapter (Item 19)
Prerequisites	The instrument must meet the prerequisites listed on page 2-15



WARNING. The generator is capable of outputting dangerous voltages. Be sure to set the DC calibration generator to off or 0 volts before connecting, disconnecting, and/or moving the test hookup during the performance of this procedure.

1. Install the test hookup and preset the instrument controls:

a. Hook up the test-signal source:

- Set the output of a DC calibration generator to off or 0 volts.
- Connect the output of a DC calibration generator as shown in Figure 2-7.

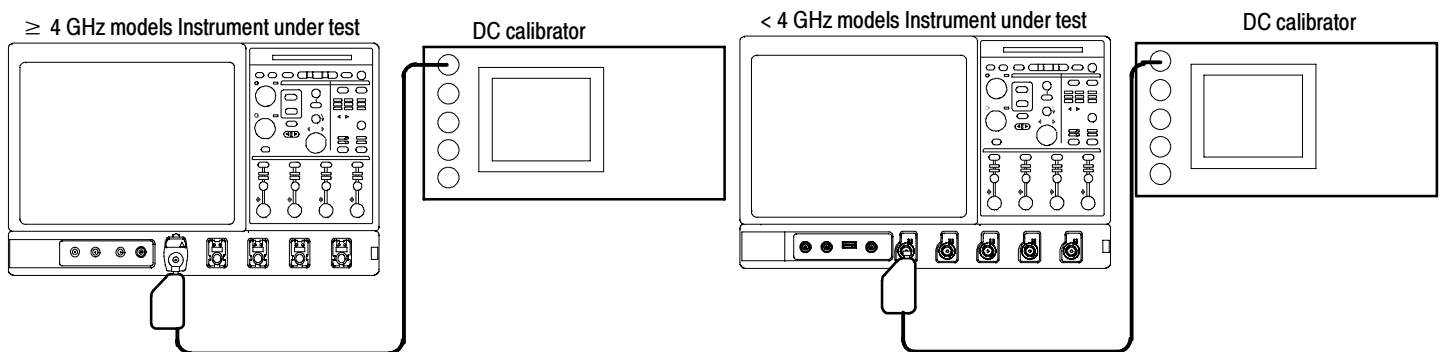

Figure 2-7: Initial test hookup

b. Initialize the instrument: Press **DEFAULT SETUP**.

NOTE. If any of the voltages supplied by your generator are not calibrated, verify those generator voltages using a digital multimeter, item 27.

- c. *Set the vertical scale:* Set the vertical **Scale** to one of the settings listed in Table 2-3 that is not yet checked. (Start with the first setting listed).

Table 2-3: DC Voltage measurement accuracy

Scale setting	Position setting (Divs)	Offset setting1	Generator setting	Accuracy limits
≥ 4 GHz models				
10 mV	-5	+0.45 V	+530 mV	+524.75 mV to +535.25 mV
	+5	-0.45 V	-530 mV	-535.25 mV to -524.75 mV
20 mV	-5	+0.4 V	+560 mV	+552.75 mV to +567.25 mV
	+5	-0.4 V	-560 mV	-567.25 mV to -552.75 mV
50 mV	-5	+0.25 V	+650 mV	+636.75 mV to +663.25 mV
	+5	-0.25 V	-650 mV	-663.25 mV to -636.75 mV
100 mV	-5	+4.5 V	+5.3 V	+5.248 V to 5.353 V
	+5	-4.5 V	-5.3 V	-5.353 V to -5.248 V
200 mV	-5	+4.0 V	+5.5 V	+5.430 V to 5.571 V
	+5	-4.0 V	-5.5 V	-5.571 V to -5.430 V
500 mV	-4	+2.5 V	+5.5 V	+5.379 V to 5.621 V
	+4	-2.5 V	-5.5 V	-5.621 V to -5.379 V
1 V	-5	0 V	+5.5 V	+5.318 V to 5.683 V
	+5	0 V	-5.5 V	-5.683 V to -5.318 V
< 4 GHz models				
1 mV	-5	+0.5 V	+507 mV	+504.25 mV to +509.76 mV
	+5	-0.5 V	-507 mV	-509.76 mV to -504.25 mV
2 mV	-5	+0.5 V	+516 mV	+513.0 mV to +519.03 mV
	+5	-0.5 V	-516 mV	-519.03 mV to -513.0 mV
5 mV	-5	+0.5 V	+540 mV	+536.3 mV to +543.7 mV
	+5	-0.5 V	-540 mV	-543.7 mV to -536.3 mV
10 mV	-5	+0.5 V	+580 mV	+574.28 mV to +585.73 mV
	+5	-0.5 V	-580 mV	-585.73 mV to -574.28 mV
20 mV	-5	+0.5 V	+660 mV	+651.8 mV to +668.2 mV
	+5	-0.5 V	-660 mV	-668.2 mV to -651.8 mV

Table 2-3: DC Voltage measurement accuracy (Cont.)

Scale setting	Position setting (Divs)	Offset setting ¹	Generator setting	Accuracy limits
50 mV	-5	+0.5 V	+900 mV	+884.38 mV to +915.63 mV
	+5	-0.5 V	-900 mV	-915.63 mV to -884.38 mV
90 mV	-5	+0.5 V	+1.22 V	+1.194 V to +1.246 V
	+5	-0.5 V	-1.22 V	-1.246 V to -1.194 V
100 mV	0	+4.5 V	+4.8 V	+4.746 V to +4.854 V
	0	-4.5 V	-4.8 V	-4.854 V to -4.746 V
200 mV	-2	+4.6 V	+4.8 V	+4.726 V to +4.875 V
	+2	-4.6 V	-4.8 V	-4.875 V to -4.726 V
500 mV	-2	+5.0 V	+4.5 V	+4.349 V to +4.651 V
	+2	-5.0 V	-4.5 V	-4.651 V to -4.349 V
1 V	0	+2.0 V	+5.0 V	+4.748 V to +5.252 V
	0	-2.0 V	-5.0 V	-5.252 V to -4.748 V

¹ Set as precisely as the instrument's offset resolution permits.

d. Display the test signal:

- From the button bar touch **Vertical** and touch **Position**.
- Use the keypad to set vertical position to a position setting listed in the table for the current vertical scale setting. The baseline level may move off screen.
- Touch **Offset**.
- Use the keypad to set vertical offset to the positive-polarity setting listed in the table for the current vertical scale setting. The baseline level will remain off screen.
- Set the generator to the level and polarity indicated in the table for the vertical scale, position, and offset settings you have made.

e. Measure the test signal: Press the **X** (close) button. Read the measurement results at the measurement statistics **Mean** measurement readout. See Figure 2-8.

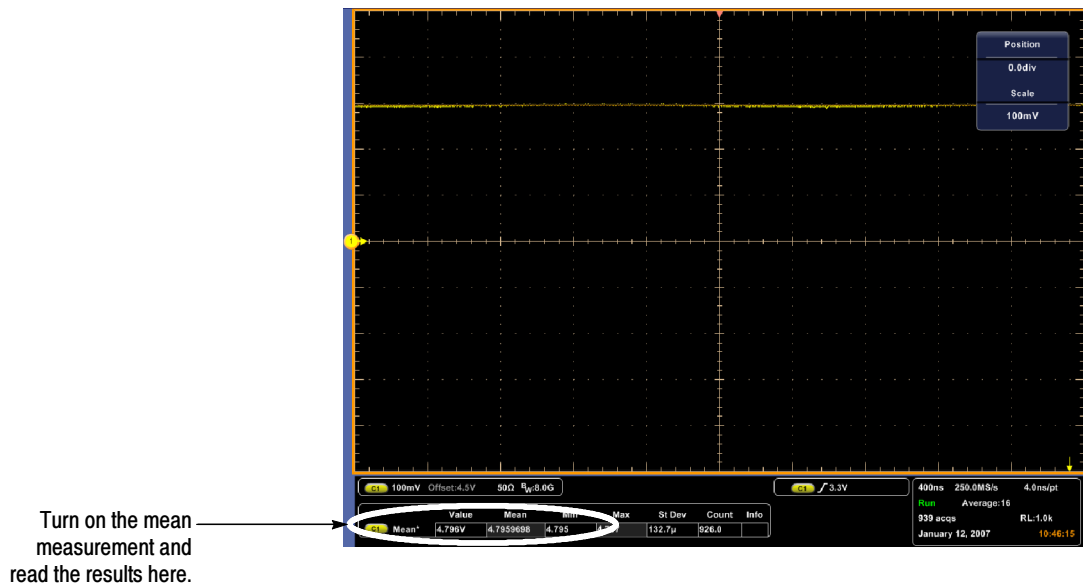

Figure 2-8: Measurement of DC accuracy at maximum offset and position

f. Check against limits:

- CHECK that the readout for the measurement **Mean** readout on screen is within the limits listed for the current vertical scale and position/offset/generator settings. Enter value on test record.
- Repeat substep d, reversing the polarity of the position, offset, and generator settings as is listed in the table.
- CHECK that the **Mean** measurement readout on screen is within the limits listed for the current vertical scale setting and position/offset/generator settings. Enter value on test record.
- Repeat substeps c through f until all vertical scale settings, listed in Table 2-3, are checked for the channel under test.

g. Test all channels: Repeat substeps a through f for all four channels.

3. Disconnect the hookup:

- a. Set the generator output to 0 V.
- b. Disconnect the equipment from the generator output and the input connector of the channel last tested.

Check DC Gain Accuracy, ≥ 4 GHz models

Equipment required	One DC calibration generator (Item 6) One SMA male-to-female BNC adapter (Item 19)
Prerequisites	The instrument must meet the prerequisites listed on page 2-15



WARNING. The generator is capable of outputting dangerous voltages. To avoid injury, be sure to set the DC calibration generator to off or 0 volts before connecting, disconnecting, and/or moving the test hookup during this procedure.

1. Install the test hookup and preset the instrument controls:

a. Hook up the test-signal source:

- Set the output of a DC calibration generator to off or 0 volts.
- Connect the generator to **Ch 1** through an adapter. See Figure 2-9.

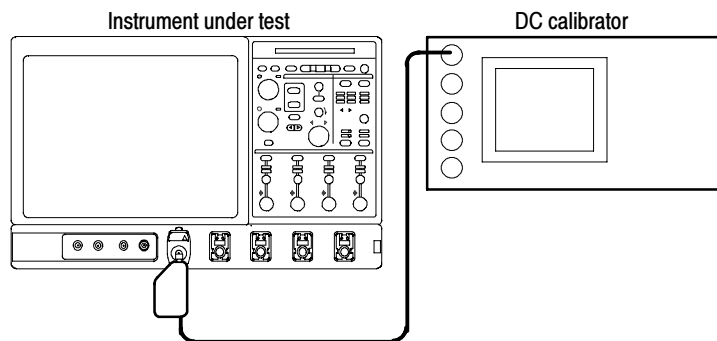

Figure 2-9: Initial test hookup

b. Initialize the instrument: Press **Default Setup**

c. Modify the default settings:

- From the tool bar, touch **Horiz/Acq** and select the **Acquisition** tab.
- Touch **Average** and set the number of averages to **16**.

2. Confirm input channels are within limits for DC gain accuracy. Do the following substeps — test Ch 1 first, skipping substep 2a since Ch 1 is already selected from step 1.

a. Select an unchecked channel:

- From the tool bar, touch **Measure** and then **Clear All** to remove the previous measurement.

- Press the Vertical button of the channel just confirmed to remove the channel from the display.
 - Press the front-panel Vertical button that corresponds to the channel you are to confirm.
 - *Set the generator output to 0 V.*
 - Move the test hookup to the channel you selected.
- b. *Turn on the measurement Mean for the channel:*
- From the tool bar, touch **Measure** and select the **Ampl** tab, **More**, and then touch **Mean** to measure the mean of the current channel.
 - Press the **X** (Close) button.
- c. *Set the vertical scale:* Set the vertical **Scale** to one of the settings in Table 2-4 that is not yet checked. (Start with the first setting listed).

Table 2-4: Gain accuracy

Channel	Scale setting	Position setting (Divs)	Offset setting	Generator setting	Measurement mean	Difference of measurement means	Accuracy limits	
≥ 4 GHz models								
Ch1	10 mV	0	0 V	+38.0 mV			+74.48 mV to +77.52 mV	
				-38.0 mV				
		-5	+0.45 V	+538 mV				+74.48 mV to +77.52 mV
				+462 mV				
		5	-0.45 V	-462 mV				+74.48 mV to +77.52 mV
				-538 mV				
	20 mV	0	0 V	+76.0 mV			+148.960 mV to +155.040 mV	
				-76.0 mV				
		-5	+0.4 V	+576.0 mV				+148.960 mV to +155.040 mV
				+424.0 mV				
		5	-0.4 V	-424.0 mV				+148.960 mV to +155.040 mV
				-576.0 mV				
50 mV	0	0 V	+190 mV			+372.40 mV to +387.60 mV		
			-190 mV					
	-5	+0.25 V	+690 mV				+372.40 mV to +387.60 mV	
			+310 mV					
	5	-0.25 V	-310 mV				+372.40 mV to +387.60 mV	

Table 2-4: Gain accuracy (Cont.)

Channel	Scale setting	Position setting (Divs)	Offset setting	Generator setting	Measurement mean	Difference of measurement means	Accuracy limits				
	100 mV	0	0 V	-690 mV			+744.80 mV to +775.20 mV				
				+380 mV							
			-5	+4.5 V		-380 mV			+744.80 mV to +775.20 mV		
						+5.38 V					
			5	-4.5 V		+4.62 V			+744.80 mV to +775.20 mV		
						-4.62 V					
				-5	+4.0 V	+5.38 V			+744.80 mV to +775.20 mV		
						+4.62 V					
		200 mV	0	0	0 V	+5.38 V			+744.80 mV to +775.20 mV		
						+4.62 V					
					-5	+4.0 V		-4.62 V			+744.80 mV to +775.20 mV
								-5.38 V			
				5	-4.0 V		+4.62 V			+744.80 mV to +775.20 mV	
							+5.38 V				
	500 mV		0	0	0 V	+760 mV			+1.49 V to +1.550 V		
						-760 mV					
				-5	+4.0 V		+5.50 V			+1.235 V to +1.285 V	
							+4.24 V				
				5	-4.0 V		-4.24 V			+1.235 V to +1.285 V	
							-5.50 V				
	1 V	0	0	0 V	+1.90 V			+3.724 V to +3.876 V			
					-1.90 V						
			-5	+2.5 V		+5.50 V			+2.352 V to +2.448 V		
						+3.10 V					
		5	-2.5 V		-3.10 V			+2.352 V to +2.448 V			
					-5.50 V						
Ch2	10 mV	0	0 V	+3.80 V			+7.448 V to +7.752 V				
				-3.80 V							
			-5	0 V		+5.50 V			+3.871 V to +4.029 V		
						+1.55 V					
			5	0 V		-1.55 V			+3.871 V to +4.029 V		
						-5.50 V					
Ch2	10 mV	0	0 V	+38.0 mV			+74.48 mV to +77.52 mV				
				-38.0 mV							
			-5	+0.45 V		+538 mV			+74.48 mV to +77.52 mV		
						+462 mV					
			5	-0.45 V		-462 mV			+74.48 mV to +77.52 mV		
						-538 mV					

Table 2-4: Gain accuracy (Cont.)

Channel	Scale setting	Position setting (Divs)	Offset setting	Generator setting	Measurement mean	Difference of measurement means	Accuracy limits		
	20 mV	0	0 V	+76.0 mV			+148.960 mV to +155.040 mV		
				-76.0 mV					
		-5	+0.4 V	+576.0 mV					+148.960 mV to +155.040 mV
				+424.0 mV					
		5	-0.4 V	-424.0 mV					+148.960 mV to +155.040 mV
				-576.0 mV					
	50 mV	0	0 V	+190 mV				+372.40 mV to +387.60 mV	
				-190 mV					
		-5	+0.25 V	+690 mV					+372.40 mV to +387.60 mV
				+310 mV					
		5	-0.25 V	-310 mV					+372.40 mV to +387.60 mV
				-690 mV					
100 mV	0	0 V	+380 mV			+744.80 mV to +775.20 mV			
			-380 mV						
	-5	+4.5 V	+5.38 V				+744.80 mV to +775.20 mV		
			+4.62 V						
	5	-4.5 V	-4.62 V				+744.80 mV to +775.20 mV		
			-5.38 V						
200 mV	0	0 V	+760 mV			+1.49 V to +1.550 V			
			-760 mV						
	-5	+4.0 V	+5.50 V				+1.235 V to +1.285 V		
			+4.24 V						
	5	-4.0 V	-4.24 V				+1.235 V to +1.285 V		
			-5.50 V						
500 mV	0	0 V	+1.90 V			+3.724 V to +3.876 V			
			-1.90 V						
	-5	+2.5 V	+5.50 V				+2.352 V to +2.448 V		
			+3.10 V						
	5	-2.5 V	-3.10 V				+2.352 V to +2.448 V		
			-5.50 V						
1 V	0	0 V	+3.80 V			+7.448 V to +7.752 V			

Table 2-4: Gain accuracy (Cont.)

Channel	Scale setting	Position setting (Divs)	Offset setting	Generator setting	Measurement mean	Difference of measurement means	Accuracy limits	
Ch3	10 mV	-5	0 V	-3.80 V			+3.871 V to +4.029 V	
				+5.50 V				
		5	0 V	-1.55 V				+3.871 V to +4.029 V
				-5.50 V				
		0	0 V	+38.0 mV				+74.48 mV to +77.52 mV
				-38.0 mV				
	-5	+0.45 V	+538 mV			+74.48 mV to +77.52 mV		
			+462 mV					
	5	-0.45 V	-462 mV			+74.48 mV to +77.52 mV		
			-538 mV					
	20 mV	0	0 V	+76.0 mV			+148.960 mV to +155.040 mV	
				-76.0 mV				
-5		+0.4 V	+576.0 mV			+148.960 mV to +155.040 mV		
			+424.0 mV					
5		-0.4 V	-424.0 mV			+148.960 mV to +155.040 mV		
			-576.0 mV					
50 mV	0	0 V	+190 mV			+372.40 mV to +387.60 mV		
			-190 mV					
	-5	+0.25 V	+690 mV			+372.40 mV to +387.60 mV		
			+310 mV					
	5	-0.25 V	-310 mV			+372.40 mV to +387.60 mV		
			-690 mV					
100 mV	0	0 V	+380 mV			+744.80 mV to +775.20 mV		
			-380 mV					
	-5	+4.5 V	+5.38 V			+744.80 mV to +775.20 mV		
			+4.62 V					
	5	-4.5 V	-4.62 V			+744.80 mV to +775.20 mV		
			-5.38 V					
200 mV	0	0 V	+760 mV			+1.49 V to +1.550 V		
			-760 mV					

Table 2-4: Gain accuracy (Cont.)

Channel	Scale setting	Position setting (Divs)	Offset setting	Generator setting	Measurement mean	Difference of measurement means	Accuracy limits	
		-5	+4.0 V	+5.50 V			+1.235 V to +1.285 V	
				+4.24 V				
		5	-4.0 V	-4.24 V			+1.235 V to +1.285 V	
				-5.50 V				
		500 mV	0	0 V	+1.90 V			+3.724 V to +3.876 V
					-1.90 V			
	-5		+2.5 V	+5.50 V			+2.352 V to +2.448 V	
				+3.10 V				
	5	-2.5 V	-3.10 V			+2.352 V to +2.448 V		
			-5.50 V					
	1 V	0	0 V	+3.80 V			+7.448 V to +7.752 V	
				-3.80 V				
		-5	0 V	+5.50 V			+3.871 V to +4.029 V	
				+1.55 V				
		5	0 V	-1.55 V			+3.871 V to +4.029 V	
				-5.50 V				
Ch4	10 mV	0	0 V	+38.0 mV			+74.48 mV to +77.52 mV	
				-38.0 mV				
		-5	+0.45 V	+538 mV			+74.48 mV to +77.52 mV	
				+462 mV				
		5	-0.45 V	-462 mV			+74.48 mV to +77.52 mV	
				-538 mV				
	20 mV	0	0 V	+76.0 mV			+148.960 mV to +155.040 mV	
				-76.0 mV				
		-5	+0.4 V	+576.0 mV			+148.960 mV to +155.040 mV	
				+424.0 mV				
		5	-0.4 V	-424.0 mV			+148.960 mV to +155.040 mV	
				-576.0 mV				
50 mV	0	0 V	+190 mV			+372.40 mV to +387.60 mV		
			-190 mV					
	-5	+0.25 V	+690 mV			+372.40 mV to +387.60 mV		

Table 2-4: Gain accuracy (Cont.)

Channel	Scale setting	Position setting (Divs)	Offset setting	Generator setting	Measurement mean	Difference of measurement means	Accuracy limits
		5	-0.25 V	+310 mV			+372.40 mV to +387.60 mV
				-310 mV			
				-690 mV			
	100 mV	0	0 V	+380 mV			+744.80 mV to +775.20 mV
				-380 mV			
		-5	+4.5 V	+5.38 V			+744.80 mV to +775.20 mV
				+4.62 V			
		5	-4.5 V	-4.62 V			+744.80 mV to +775.20 mV
				-5.38 V			
	200 mV	0	0 V	+760 mV			+1.49 V to +1.550 V
				-760 mV			
		-5	+4.0 V	+5.50 V			+1.235 V to +1.285 V
				+4.24 V			
		5	-4.0 V	-4.24 V			+1.235 V to +1.285 V
				-5.50 V			
	500 mV	0	0 V	+1.90 V			+3.724 V to +3.876 V
				-1.90 V			
		-5	+2.5 V	+5.50 V			+2.352 V to +2.448 V
				+3.10 V			
		5	-2.5 V	-3.10 V			+2.352 V to +2.448 V
				-5.50 V			
	1 V	0	0 V	+3.80 V			+7.448 V to +7.752 V
				-3.80 V			
		-5	0 V	+5.50 V			+3.871 V to +4.029 V
+1.55 V							
5		0 V	-1.55 V			+3.871 V to +4.029 V	
			-5.50 V				

d. *Display the test signal:*

- From the tool bar touch **Vertical** and then touch **Position**.

- Use the keypad to set vertical position to the number of divisions listed in the table for the current vertical scale setting and offset.
 - Touch **Offset**.
 - Use the keypad to set vertical offset to the setting listed in the table for the current vertical scale and position settings. The baseline level may move off screen.
 - Set the generator to the level and polarity indicated in the table for the vertical scale, position, and offset settings you have made. The DC test level should appear on screen. (If it doesn't return, the accuracy check has failed for the current vertical scale, position, and offset settings of the current channel).
- e. *Measure the test signal:* Press the **Close** button.
- Read the measurement results at the measurement statistics **Mean** measurement readout. See Figure 2-10.
 - Record the Mean in the Measurement Mean column of Table 2-4.

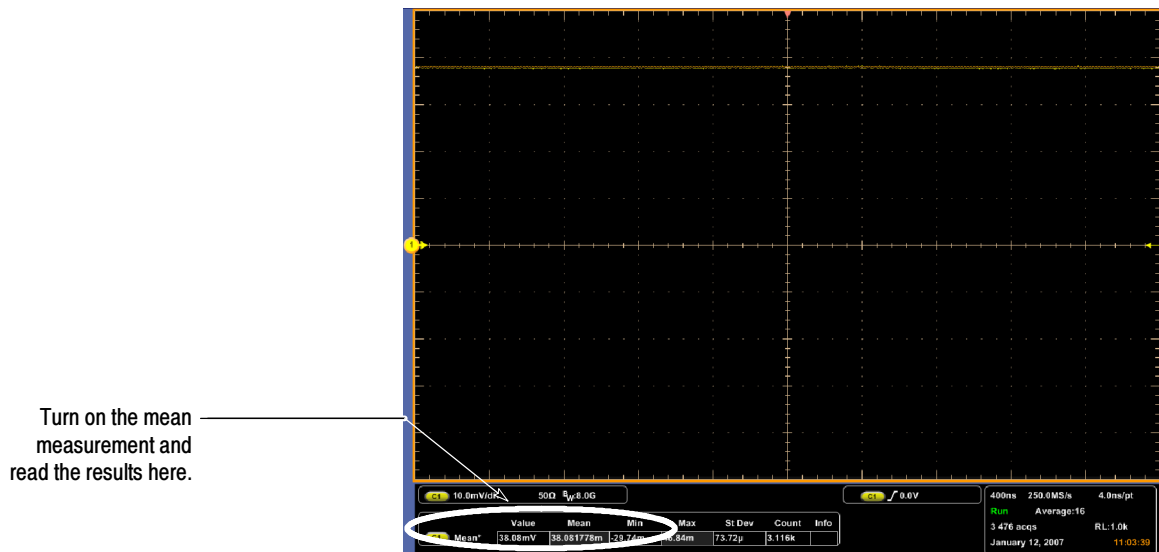

Figure 2-10: Measurement of DC gain accuracy

- f. *Measure second mean:*
- Set the generator to the second level and polarity indicated in the table for the vertical scale, position, and offset settings you have made.

- Repeat substep e using the current vertical scale, position, offset, and new generator setting for the second mean.
 - g. *Check against limits:*
 - Subtract the second measurement mean from the first measurement mean for the current vertical scale, position, and offset.
 - Record the difference of the two mean measurements in the Difference of Measurement Means column of Table 2-4.
 - CHECK that the Difference of Measurement Mean is within the limits listed for the current vertical scale/position/offset/generator settings. Enter measurement mean difference value on test record.
 - h. Repeat substeps d through g, using the next position, offset and generator settings listed in the table for the current vertical scale.
 - i. Repeat substeps c through h until all vertical scale settings, listed in Table 2-4, are checked for the channel under test.
 - j. *Test all channels:* Repeat substeps a through i for all four channels.
- 3. *Disconnect the hookup:*
 - a. *Set the generator output to 0 V.*
 - b. Disconnect the generator output from the channel last tested.

**Check Offset Accuracy
≥ 4 GHz models**

Equipment required	One DC calibration generator (Item 6) One SMA male-to-female BNC adapter (Item 19)
Prerequisites	The instrument must meet the prerequisites listed on page 2-15



WARNING. *The generator is capable of outputting dangerous voltages. To avoid injury, be sure to set the DC calibration generator to off or 0 volts before connecting, disconnecting, and/or moving the test hookup during this procedure.*

1. *Install the test hookup and preset the instrument controls:*
 - a. *Hook up the test-signal source:*
 - Set the output of a DC calibration generator to off or 0 volts.
 - Connect the output of a DC calibration generator to **Ch 1** through an adapter. See Figure 2-11.

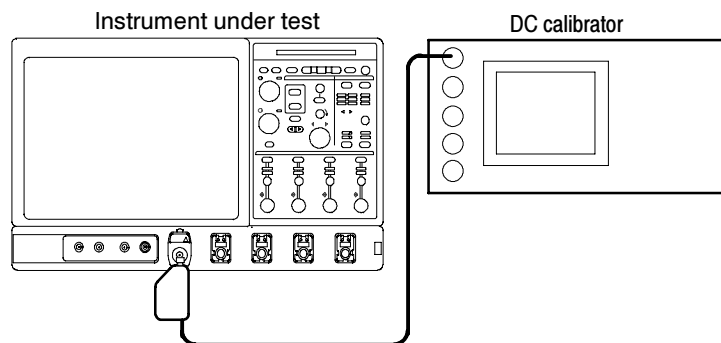

Figure 2-11: Initial test hookup

- b. *Initialize the instrument:* Press **Default Setup**.
 - c. *Modify the default settings:*
 - From the tool bar, touch **Horiz/Acq** and select the **Acquisition** tab.
 - Touch **Average** and set the number of averages to **16**.
 2. *Confirm input channels are within limits for offset accuracy.* Do the following substeps — test Ch 1 first, *skipping substep 2a since Ch 1 is already selected from step 1.*
 - a. *Select an unchecked channel:*
 - From the tool bar, touch **Measure** and then **Clear All** to remove the previous measurement.
 - Press the Vertical button of the channel just confirmed to remove the channel from the display.
 - Press the front-panel Vertical button that corresponds to the channel you are to confirm.
 - *Set the generator output to 0 V.*
 - Move the test hookup to the channel you selected.
 - b. *Turn on the measurement Mean for the channel:*
 - From the tool bar, touch **Measure** and select the **Ampl** tab, **More**, and then touch **Mean** to measure the mean of the current channel.
 - Press the **X** (Close) button.
 - c. *Set the vertical scale:* Set the vertical **Scale** to one of the settings in Table 2-5 that is not yet checked.

Table 2-5: Offset accuracy

Scale setting	Position setting (Divs)	Offset setting ¹	Generator setting	Accuracy limits
≥ 4 GHz models				
10 mV	-5	+0.45 V	+500 mV	+495.75 mV to +504.25 mV
	5	-0.45 V	-500 mV	-504.25 mV to -495.75 mV
20 mV	-5	+0.4 V	+500 mV	+494.75 mV to +505.25 mV
	5	-0.4 V	-500 mV	-505.25 mV to -494.75 mV
50 mV	-5	+0.25 V	+500 mV	+491.75 mV to +508.25 mV
	5	-0.25 V	-500 mV	-508.25 mV to -491.75 mV
100 mV	-5	+4.5 V	+5.0 V	+4.958 V to +5.043 V
	5	-4.5 V	-5.0 V	-5.043 V to -4.958 V
200 mV	-5	+2 V	+3.0 V	+2.955 V to +3.046 V
	5	-2 V	-3.0 V	-3.046 V to -2.955 V
500 mV	-5	+2.5 V	+5.0 V	+4.918 V to +5.083 V
	5	-2.5 V	-5.0 V	-5.083 V to -4.918 V
1 V	-5	0 V	2.5 V	+2.368 V to +2.633 V
	5	0 V	-2.5 V	-2.633 V to -2.368 V

¹ Set as precisely as the instrument's offset resolution permits.

d. *Display the test signal:*

- From the tool bar touch **Vertical** and then touch **Position**.
- Use the keypad to set vertical position to the setting listed in the table.
- Touch **Offset**.
- Use the keypad to set vertical offset to the positive-polarity setting listed in the table for the current vertical scale setting. The baseline level may move off screen.
- Set the generator to the level and polarity indicated in the table for the vertical scale, position, and offset settings you have made.

e. *Measure the test signal:* Press **Close**. Read the measurement results at the **Mean** measurement readout. See Figure 2-12.

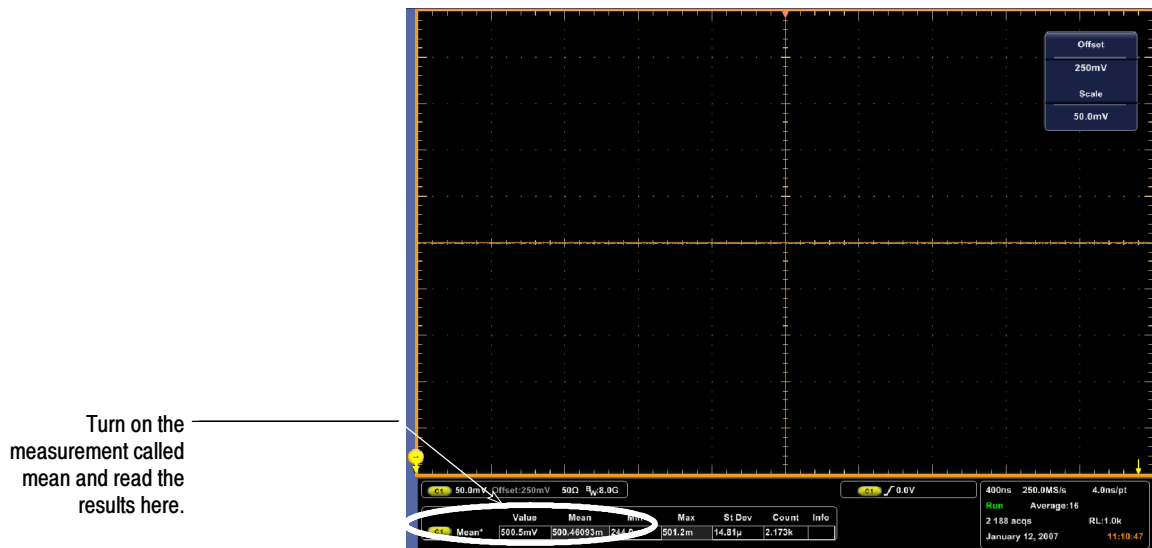

Figure 2-12: Measurement of offset accuracy

f. Check against limits:

- CHECK that the readout for the measurement **Mean** readout on screen is within the limits listed for the current vertical scale and position/offset/generator settings. Enter the value on the test record.
- Repeat substep d, using the offset and generator settings as is listed in the table.
- CHECK that the **Mean** measurement readout on screen is within the limits listed for the current vertical scale setting and position/offset/generator settings. Enter the value on the test record.
- Repeat substep d, using the negative-polarity offset and generator settings as is listed in the table.
- CHECK that the **Mean** measurement readout on screen is within the limits listed for the current vertical scale setting and position/offset/generator settings. Enter the value on the test record.
- Repeat substeps c through f until all vertical scale settings, listed in Table 2-5, are checked for the channel under test.

g. Test all channels: Repeat substeps a through f for all four channels.

3. Disconnect the hookup:

- a. Set the generator output to 0 V.
- b. Disconnect the generator from the channel last tested.

**Check Analog Bandwidth,
< 3.5 GHz models**

Equipment required	One sine wave generator (Item 9)
Prerequisites	See page 2-15

NOTE. *The sine wave generator output amplitude must be leveled to within 0.35 dB of the reference frequency (50 MHz) through the bandwidth frequency listed in Table 2-6 starting on page 2-56. The 0.35 dB requirement is necessary to ensure a bandwidth that meets Tektronix specifications.*

You can perform bandwidth PV using an unleveled sine wave generator (with amplitude error > 0.35 dB). Under these conditions, the bandwidth PV is subject to the flatness errors associated with the generator used.

Refer to the Sine Wave Generator Leveling Procedure on page 2-104 if your sine wave generator does not have automatic output amplitude leveling.

1. *Install the test hookup and preset the instrument controls:*

a. *Initialize the instrument:*

- Press **Default Setup**.

b. *Modify the default settings:*

- Touch **Vertical**, select **Vertical Setup**, and then touch **Termination 50 Ω**.
- Turn the horizontal **Scale** knob to 20 ns.
- From the button bar, touch **Horiz/Acq** and select the **Horizontal** tab. Set the Record Length to 48,000.
- From the button bar, touch **Horiz/Acq** and select the **Acquisition** tab. Set the acquisition mode as follows:
 - Touch **Average** and set the number of averages to **16**.
- Set the sampling mode as follows:
 - Touch the **Equivalent ET** button.
- From the button bar, touch **Measure**. Touch **Setup Ref Levs**; then touch the **Histogram** button.

NOTE. The sine wave generator output amplitude must be leveled to within 0.35 dB of the reference frequency (50 MHz) through the bandwidth frequency listed in Table 2-6 starting on page 2-56. The 0.35 dB requirement is necessary to ensure a bandwidth that meets Tektronix specifications.

You can perform bandwidth PV using an unleveled sine wave generator (with amplitude error > 0.35 dB). Under these conditions, the bandwidth PV is subject to the flatness errors associated with the generator used.

- c. *Hook up the test-signal source:* Connect the sine wave output of a leveled sine wave generator to **Ch 1**. Set the output of the generator to a reference frequency of 50 MHz or less. See Figure 2-13.

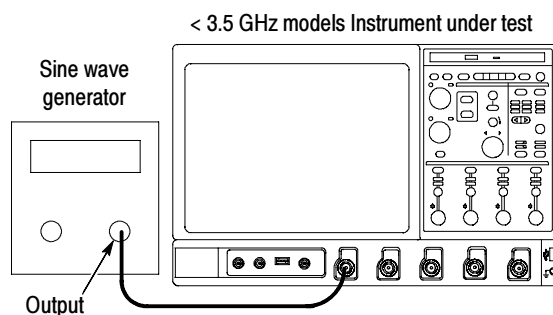

Figure 2-13: Initial test hookup

2. *Confirm the input channels are within limits for analog bandwidth:* Do the following substeps — test Ch 1 first, *skipping substeps a and b since Ch 1 is already set up for testing from step 1.*
 - a. *Select an unchecked channel:*
 - From the button bar, touch **Measure** and then **Clear All** to remove the previous measurement.
 - Press the Vertical button of the channel just confirmed to remove the channel from the display.
 - Press the front-panel Vertical button that corresponds to the channel you are to confirm.
 - Touch **Vertical**, select **Vertical Setup**, and then touch Termination **50 Ω**.
 - Move the leveled output of the sine wave generator to the channel you selected.

- b. *Match the trigger source to the channel selected:* Press the **Trigger Source** button until the source that corresponds to the channel you are to confirm is on.

Table 2-6: Analog bandwidth, < 3.5 GHz models

Vertical scale	Reference amplitude	Horizontal scale	Test frequency			-3 dB Limits
			DPO7254	DPO7104	DPO7054	
1 mV	6 mV	1 ns	200 MHz	200 MHz	200 MHz	≥4.24 mV
2 mV	12 mV	1 ns	500 MHz	500 MHz	400 MHz	≥8.48 mV
5 mV	30 mV	1 ns	2.0 GHz	1 GHz	500 MHz	≥21.2 mV
10 mV	60 mV	1 ns	2.5 GHz	1 GHz	500 MHz	≥42.4 mV
20 mV	120 mV	1 ns	2.5 GHz	1 GHz	500 MHz	≥84.8 mV
50 mV	300 mV	1 ns	2.5 GHz	1 GHz	500 MHz	≥212 mV
100 mV	600 mV	1 ns	2.5 GHz	1 GHz	500 MHz	≥424 mV
200 mV	1.2 V	1 ns	2.5 GHz	1 GHz	500 MHz	≥848 mV
500 mV	3 V ¹	1 ns	2.5 GHz	1 GHz	500 MHz	≥2.12 V ¹
1 V	5 V ¹	1 ns	2.5 GHz	1 GHz	500 MHz	≥3.535 V ¹

¹ If your generator cannot output the required amplitude, determine its maximum output at the Test frequency, and use this for the reference amplitude. The -3 dB limit can be calculated as: $0.707 \times$ reference amplitude.

- c. *Set the vertical scale:*

Set the vertical **Scale** that corresponds to the channel you are to confirm to one of the settings listed in Table 2-6 not yet checked. (Start with the 100 mV setting).

- d. *Set the triggering coupling:* Touch the **Coupling DC** button.

- e. *Display the test signal:* Do the following subparts to first display the reference signal and then the test signal.

- From the button bar touch **Measure**; then select the **Time** tab.
- Touch the **Freq** button to measure the frequency of the current channel.
- Select the **Ampl** tab. Touch the **Amplitude** button.
- Touch the **Statistics** button, then touch the **Mean** button.
- Touch the **X** (Close) button.

- Set the generator output so the Chx Amplitude mean readout equals the reference amplitude in Table 2-6 that corresponds to the vertical scale set in substep c.

- Set the trigger as follows:

Press the front-panel **Push-Set 50%** as necessary to trigger a stable display. At full bandwidth, you may also want to make small, manual adjustments to the trigger level. You can use the **Trigger Level** knob to do this.

f. *Measure the test signal:*

- Set the frequency of the generator, as shown on screen, to the test frequency in Table 2-6 that corresponds to the vertical scale set in substep c. See Figure 2-14.
- Set the horizontal **Scale** to the horizontal scale setting in Table 2-6 that corresponds to the vertical scale set in substep c. Press **PUSH-SET 50%** as necessary to trigger the signal.
- Read the results at the Chx Amplitude mean readout, which will automatically measure the amplitude of the test signal. See Figure 2-14.

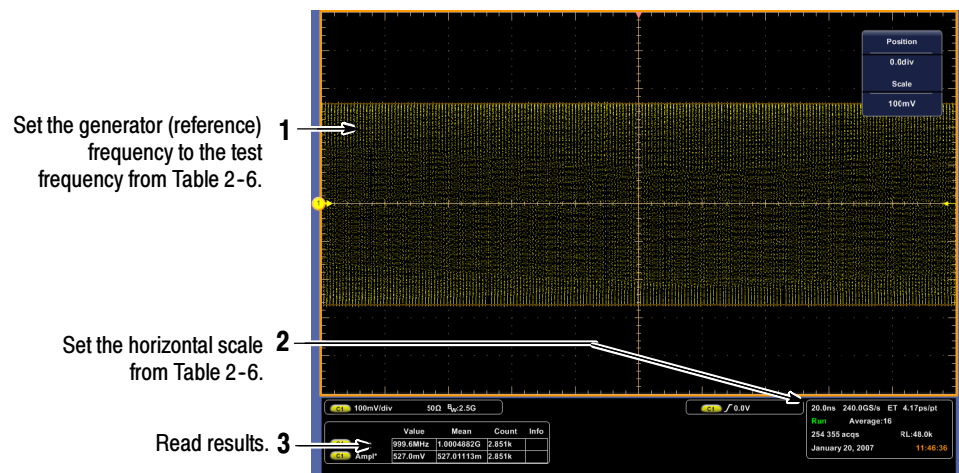

Figure 2-14: Measurement of analog bandwidth

g. *Check against limits:*

- CHECK that the **Amplitude** mean readout on screen is within the limits listed in Table 2-6 for the current vertical scale setting.
- Enter the voltage on the test record.

- When finished checking, set the horizontal **Scale** back to the 20 ns.

STOP. *Checking the bandwidth of each channel at all vertical scale settings is time consuming and unnecessary. You may skip checking the remaining vertical scale settings (that is, skip the following substep, h) if this instrument has performed as follows:*

- Passed the 100 mV vertical scale setting just checked in this procedure.
- Passed the *Verify Internal Adjustment, Self Compensation, and Diagnostics* procedure found under *Self Tests*, on page 2-5.

NOTE. *Passing the signal path compensation confirms the signal path for all vertical scale settings for all channels. Passing the internal diagnostics ensures that the factory-set adjustment constants that control the bandwidth for each vertical scale setting have not changed.*

h. *Check remaining vertical scale settings against limits (optional):*

- If desired, finish checking the remaining vertical scale settings for the channel under test by repeating substeps c through g for each of the remaining scale settings for the channel under test.
- When doing substep e, skip the subparts that turn on the Chx Amplitude mean measurement until you check a new channel.
- Before doing substep f, touch the **Clear All** button to remove the previous channel measurements.
- Install/remove attenuators between the generator leveled output and the channel input as needed to obtain the six division reference signals listed in the table.

i. *Test all channels:* Repeat substeps a through g for all four channels.

- 3.** *Disconnect the hookup:* Disconnect the test hook up from the input connector of the channel last tested.

**Check Analog Bandwidth,
≥ 3.5 GHz models**

Equipment required	One sine wave generator (Item 9) One level meter and power sensor (Item 10) One power splitter (Item 11) 50 Ω precision cable 2.92 mm male-to-female (Item 12) One K male-to-male adapter (Item 13) SMA male-to-BNC female adapter (Item 19)
Prerequisites	See page 2-15

1. *Install the test hookup and preset the instrument controls:*
 - a. *Initialize the instrument:*
 - Press **Default Setup**.
 - b. *Modify the default settings:*
 - DPO7354: Touch **Vertical**, select **Vertical Setup**, and then touch **Termination 50 Ω**.
 - Turn the horizontal **Scale** knob to 20 ns.
 - From the button bar, touch **Horiz/Acq** and select the **Horizontal** tab. Set the Record Length to 50,000 (48,000 for DPO7354).
 - From the button bar, touch **Horiz/Acq** and select the **Acquisition** tab. Set the acquisition mode as follows:
 Touch **Sample**.
 - Set the sampling mode as follows:
 Touch the **Interpolated IT** button.
 - From the button bar, touch **Measure**. Touch Setups **Ref Levs**; then touch the **Histogram** button.
 - If your instrument has enhanced bandwidth, from the toolbar, touch **Vertical** and select Bandwidth Enhanced **AUTO** (maximum bandwidth). Select **Apply to All Channels**.
 - c. *Hook up the test-signal source:* Connect the sine wave output of the sine wave generator to **Ch 1** through a power splitter. Connect the power sensor of the power meter to the power splitter. Set the output of the generator to a reference frequency of 50 MHz. See Figure 2-15.

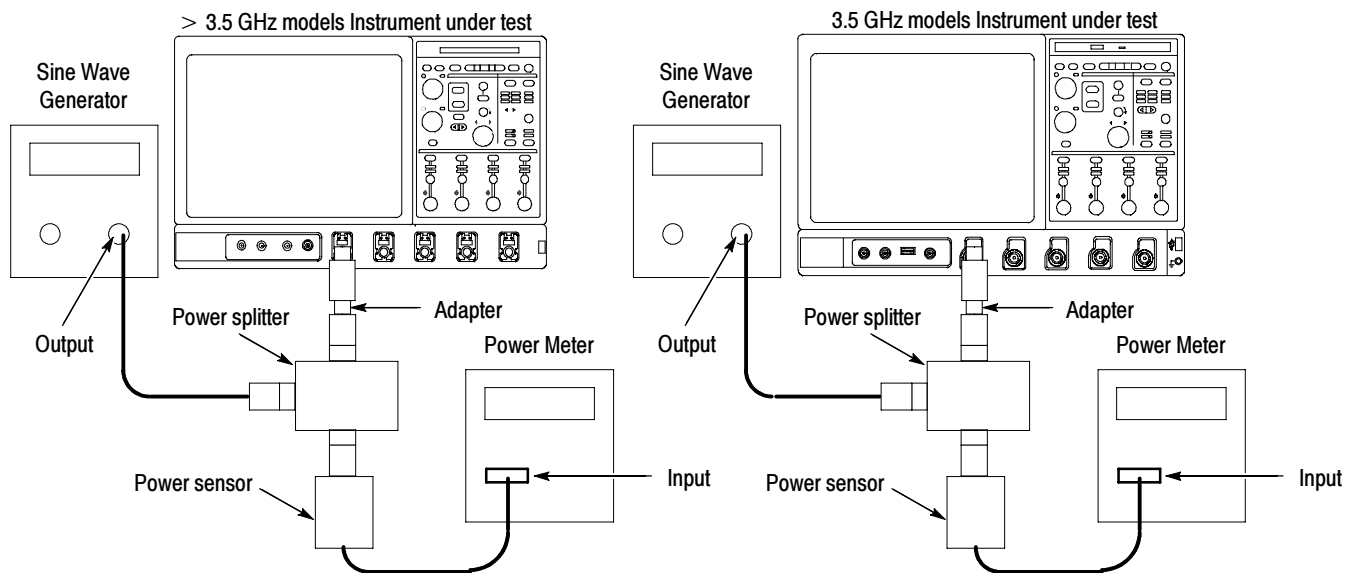

Figure 2-15: Initial test hookup

2. *Confirm the input channels are within limits for analog bandwidth: Do the following substeps — test Ch 1 first, skipping substeps a and b since Ch 1 is already set up for testing from step 1.*
 - a. *Select an unchecked channel:*
 - From the button bar, touch **Measure** and then **Clear All** to remove the previous measurement.
 - Press the Vertical button of the channel just confirmed to remove the channel from the display.
 - Press the front-panel Vertical button that corresponds to the channel you are to confirm.
 - DPO7354: Touch **Vertical**, select **Vertical Setup**, and then touch Termination **50 Ω**.
 - Move the test setup to the channel you selected.
 - b. *Match the trigger source to the channel selected:* Press the **Trigger Source** button until the source that corresponds to the channel you are to confirm is on.
 - ≥ 3.5 GHz models with bandwidth >9 GHz: Set the trigger Source to **Line**.

- c. From the toolbar, touch **Vertical** and select Bandwidth Enhanced **AUTO** (maximum bandwidth). Select **Apply to All Channels**.

Table 2-7: Analog bandwidth

Vertical scale	Reference amplitude (6 div)	Horizontal scale	Test frequency						-3 dB Limits
			DSA/DPO72004	DSA/DPO71604	DSA/DPO71254	DSA/DPO70804	DSA/DPO70604	DSA/DPO70404	
10 mV	60 mV	1 ns	18 GHz	16 GHz	12.5 GHz	8 GHz	6 GHz	4 GHz	≥42.4 mV
20 mV	120 mV	1 ns	20 GHz	16 GHz	12.5 GHz	8 GHz	6 GHz	4 GHz	≥84.8 mV
50 mV	300 mV	1 ns	20 GHz	16 GHz	12.5 GHz	8 GHz	6 GHz	4 GHz	≥212 mV
100 mV	600 mV	1 ns	18 GHz	16 GHz	12.5 GHz	8 GHz	6 GHz	4 GHz	≥424 mV
200 mV	1.2 V	1 ns	20 GHz	16 GHz	12.5 GHz	8 GHz	6 GHz	4 GHz	≥848 mV
500 mV	3 V ¹	1 ns	20 GHz	16 GHz	12.5 GHz	8 GHz	6 GHz	4 GHz	≥2.12 V ¹
1 V	5 V ¹	1 ns	NA	NA	12.5 GHz	8 GHz	6 GHz	4 GHz	≥3.535 V ¹

¹ If your generator cannot output the required amplitude, determine its maximum output at the Test frequency, and use this for the reference amplitude. The -3 dB limit can be calculated as: $0.707 \times$ reference amplitude.

Table 2-8: Analog bandwidth

Vertical scale	Reference amplitude	Horizontal scale	Test frequency	-3 dB Limits
			DPO7354	
1 mV	4 mV	1 ns	200 MHz	≥2.83 mV
2 mV	8 mV	1 ns	500 MHz	≥5.66 mV
5 mV	20 mV	1 ns	2.0 GHz	≥14.1 mV
10 mV	40 mV	1 ns	3.5 GHz	≥28.3 mV
20 mV	80 mV	1 ns	3.5 GHz	≥56.6 mV
50 mV	200 mV	1 ns	3.5 GHz	≥141.4 mV
100 mV	400 mV	1 ns	3.5 GHz	≥283 mV
200 mV	800 mV	1 ns	3.5 GHz	≥566 mV
500 mV	2 V ¹	1 ns	3.5 GHz	≥1.41 V ¹
1 V	4 V ¹	1 ns	3.5 GHz	≥2.83 V ¹

¹ If your generator cannot output the required amplitude, determine its maximum output at the Test frequency, and use this for the reference amplitude. The -3 dB limit can be calculated as: $0.707 \times$ reference amplitude.

d. DPO7354: Set the input impedance to 50 Ω .

e. *Set the vertical scale:*

Set the vertical **Scale** that corresponds to the channel you are to confirm to one of the settings listed in Table 2-7 or Table 2-8 not yet checked. (Start with the 100 mV setting).

f. *Set the triggering coupling:* Touch **Trigger** and select Coupling **DC**.

g. *Display the test signal:* Do the following subparts to first display the reference signal and then the test signal.

- From the button bar touch **Measure**; then select the **Time** tab.
- Touch the **Freq** button to measure the frequency of the current channel.
- Select the **Ampl** tab. Touch the **Amplitude** button.
- Touch the **Statistics** button, then touch the **Mean** button.
- Touch the **X** (Close) button.
- Set the generator output so the Chx Amplitude mean readout equals the reference amplitude in Table 2-7 or Table 2-8 that corresponds to the vertical scale set in substep c.
- Record the reading on the power meter.
- Set the trigger as follows:

Press the front-panel **Push-Set 50%** as necessary to trigger a stable display. At full bandwidth, you may also want to make small, manual adjustments to the trigger level. You can use the **Trigger Level** knob to do this.

NOTE. *If you are using Line trigger, the test signal is not shown as a stable display.*

h. *Measure the test signal:*

- Set the frequency of the generator, as shown on screen, to the test frequency in Table 2-7 or Table 2-8 that corresponds to the vertical scale set in substep c. See Figure 2-16.
- Set the horizontal **Scale** to the horizontal scale setting in Table 2-7 or Table 2-8 that corresponds to the vertical scale set in substep c. Press **PUSH-SET 50%** as necessary to trigger the signal.

- Adjust the output of the generator until the reading on the power meter is equal to the reading recorded on the power meter in step g.
- Read the results at the Chx Amplitude mean readout, which will automatically measure the amplitude of the test signal. See Figure 2-16.

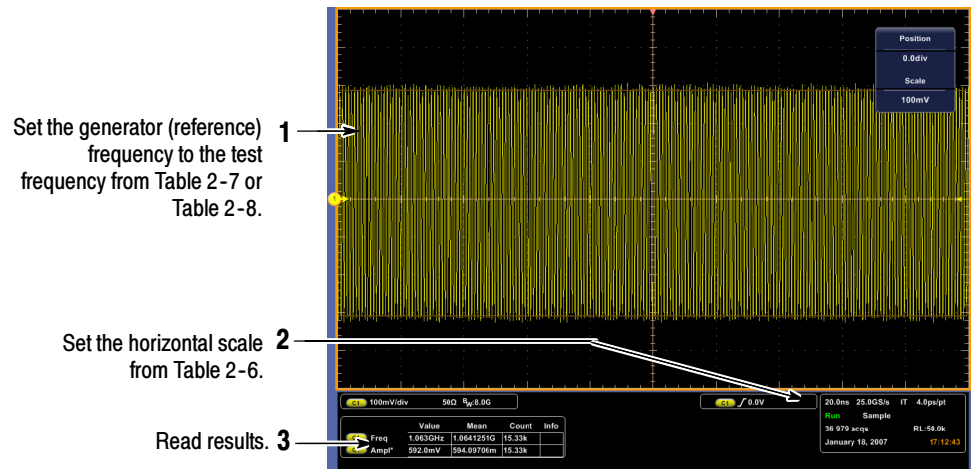

Figure 2-16: Measurement of analog bandwidth

i. *Check against limits:*

- CHECK that the **Amplitude** mean readout on screen is within the limits listed in Table 2-7 or Table 2-8 for the current vertical scale setting.
- Enter the voltage on the test record.
- When finished checking, set the horizontal **Scale** back to the 20 ns.

STOP. Checking the bandwidth of each channel at all vertical scale settings is time consuming and unnecessary. You may skip checking the remaining vertical scale settings (that is, skip the following substep, h) if this instrument has performed as follows:

- Passed the 100 mV vertical scale setting just checked in this procedure.
- Passed the *Verify Internal Adjustment, Self Compensation, and Diagnostics* procedure found under *Self Tests*, on page 2-5.

NOTE. Passing the signal path compensation confirms the signal path for all vertical scale settings for all channels. Passing the internal diagnostics ensures that the factory-set adjustment constants that control the bandwidth for each vertical scale setting have not changed.

- j. Check remaining vertical scale settings against limits (optional):
 - If desired, finish checking the remaining vertical scale settings for the channel under test by repeating substeps c through g for each of the remaining scale settings for the channel under test.
 - When doing substep g, skip the subparts that turn on the Chx Amplitude mean measurement until you check a new channel.
 - When selecting a new channel and before doing substep f, touch the **Clear All** button to remove the previous channel measurements.
 - k. Test all channels: Repeat substeps a through g for all four channels.
3. Disconnect the hookup: Disconnect the test hook up from the input connector of the channel last tested.

**Check Input Resistance,
≥ 4 GHz models**

Equipment required	One Digital Multimeter (Item 27) One Dual-Banana Connector, (Item 5) One precision 50 Ω coaxial cable (Item 4) One SMA male-to-female BNC adapter (Item 19)
Prerequisites	See page 2-15

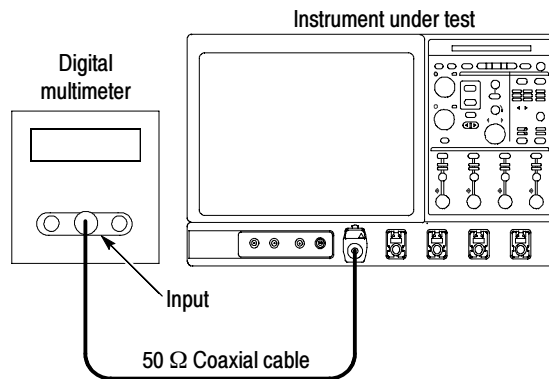

Figure 2- 17: Initial test hookup

1. *Install the test hookup and preset the instrument controls:*
 - a. *Initialize the instrument:* Press the **Default Setup** button.
 - b. *Hook up the test-signal source:* Connect, through a 50 Ω precision coaxial cable, the input of the multimeter to **Ch 1** through adapters (see Figure 2-17).
 - c. Set the Vertical **Scale** to **10 mV** per division
2. *Check input impedance against limits:*
 - a. *Measure the impedance:* Read and record the measured impedance.
 - b. Remove the dual banana connector from the digital multimeter (DMM), turn it 180 degrees and reinsert it in the DMM input.
 - c. *Measure the impedance:* Read and record the measured impedance.
 - d. Add the two measurements and divide the result by 2.
 - e. Check — Average of the two measurements is $\geq 49.25 \Omega$ and $\leq 50.75 \Omega$. Enter average on the test record.
3. Set the Vertical **Scale** to **100 mV** per division and repeat step 2.
4. *Repeat steps 2 through 3 for the remaining input channels:*
 - a. Move the test setup to an unchecked input channel.
 - b. Set the Vertical **Scale** of the channel to **10 mV** per division.
 - c. Repeat steps 2 through 3.
5. *Disconnect the hookup:* Disconnect the equipment from the instrument.

Time Base System Checks

These procedures check those characteristics that relate to the time base system and are listed as checked under *Warranted Characteristics* in *Specifications*.

Check Timbase and Delay Time Accuracy and Reference

Equipment required	One timer-counter (Item 8) One 50 Ω , precision coaxial cable (Item 4) One SMA male-to-female BNC adapter (Item 19) One sine wave generator (Item 9)
Prerequisites	See page 2-15

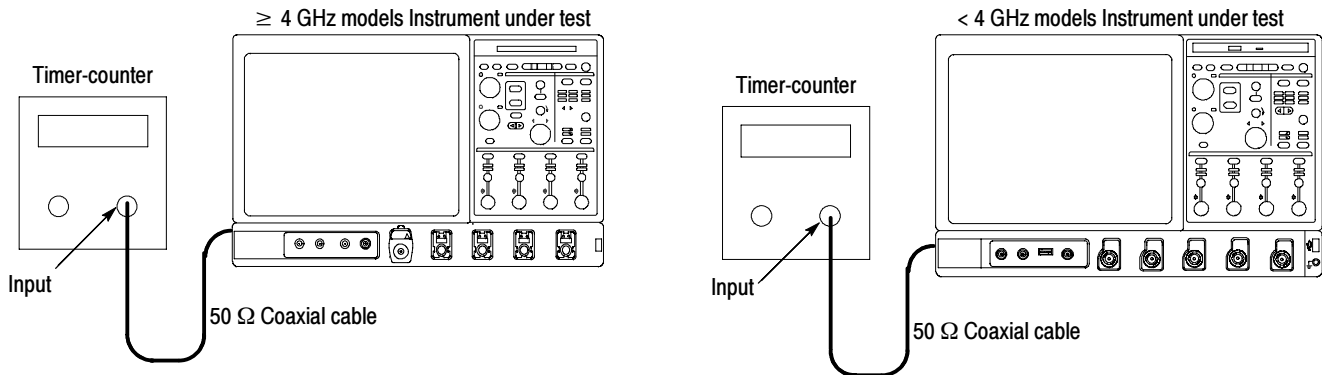

Figure 2-18: Initial test hookup

1. *Install the test hookup and preset the instrument controls:*
 - a. *Hook up the test-signal source:* Connect the input of the timer-counter to **AUX OUT** (< 4 GHz models) or **REF OUT** (≥ 4 GHz models) as shown in Figure 2-18.
 - Set the timer-counter gate to 1 s.
 - Set the timer-counter to count the 10 MHz reference output.
 - b. *Initialize the instrument:* Press the **Default Setup** button.
 - c. < 4 GHz models: Display menu mode. Select Utilities > External Signals and press **Ref Out**.

2. *Confirm the time base is within limits for accuracies:*
 - a. *Check long-term sample rate, delay time accuracies, and reference output frequency:*
 - CHECK that the count on the timer-counter is within limits (see limits on page 2-33).
 - Enter the count on the test record.
3. *Disconnect the hookup:* Disconnect the equipment from the instrument.

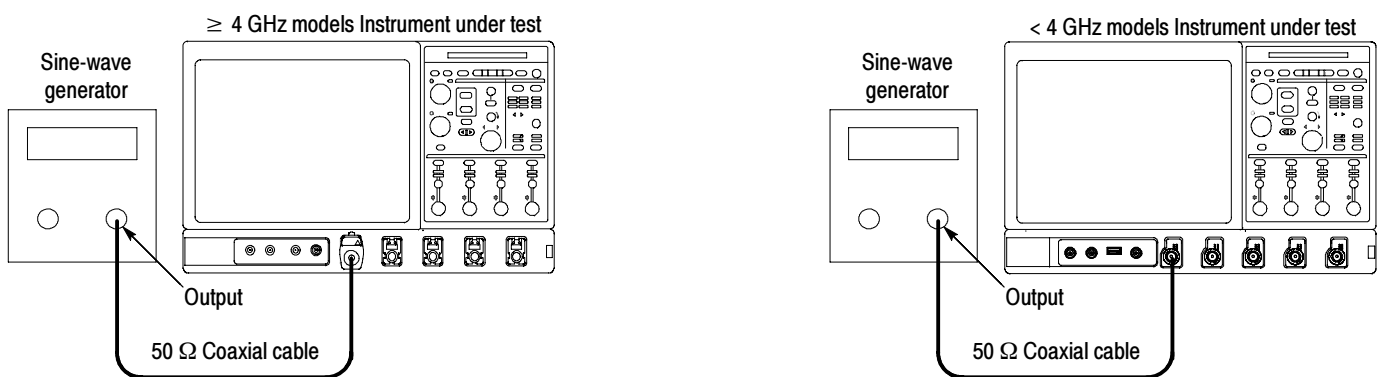

Figure 2-19: Initial test hookup

4. *Install the test hookup and preset the instrument controls:*
 - a. *Initialize the instrument:* Press the **Default Setup** button.
 - b. *Hook up the test-signal source:* Connect the output of the sine wave generator to **Ch 1** input as shown in Figure 2-19.
 - From the button bar, touch **Measure** and select the **Ampl** tab.
 - Touch the **Pk-Pk** button.
 - Touch the **X (Close)** button.
 - Set the **Vertical Scale** to 50 mV.
 - < 4 GHz models: Touch **Vertical**, select **Vertical Setup**, and then touch Termination **50 Ω** .
 - Set the generator for a 10.0 MHz sine wave.
 - Set the generator to output a 4 division signal. Adjust the output until the Pk-Pk readout displays 200 mV.

c. *Set the instrument controls:*

- Move the cable from the **Ch 1** input to the rear-panel **Ext Ref** input (see Figure 2-20).
- From menu mode, touch **Utilities** and select **External Signals**.
- Touch the **External** button to select the external reference.

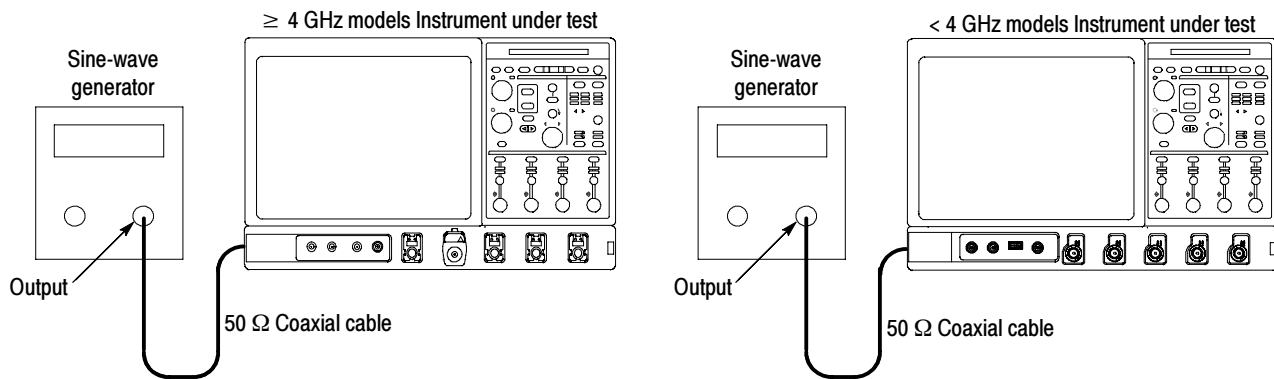

Figure 2-20: Final test hookup

5. *Confirm external reference:*

a. *Perform a signal path compensation:*

- Touch **Utilities** and select **Instrument Calibration**.
- Touch **Calibrate** and wait for the signal path compensation to finish.

b. *Check the completion status:* Enter the pass/fail status in the test record. If the Status is Fail, refer the instrument to qualified service personnel.

6. *Disconnect the hookup:*

a. Disconnect all test equipment from the instrument.

b. *Set the instrument controls:*

- From menu mode, touch **Utilities** and select **External Signals**.
- Touch the **Internal** button to select the internal reference.

c. *Perform a signal path compensation:*

- Touch **Utilities** and select **Instrument Calibration**.
- Touch **Calibrate** and wait for the signal path compensation to finish.

Check Delta Time Measurement Accuracy, < 4 GHz models

Equipment required	<p>One 50 Ω, precision coaxial cable (Item 4)</p> <p>One 50 Ω, 60 inch precision coaxial cable, male-to-male SMA connectors (Item 28)</p> <p>One Pulse Generator (Item 20)</p> <p>One BNC elbow connector (Item 24)</p> <p>One SMA “T”, male to two SMA female connectors (Item 22)</p> <p>One SMA female to BNC male connector (Item 23)</p> <p>One SMA termination connectors, short circuit, (Item 25)</p> <p>< 4 GHz models: One SMA male-to-female BNC adapter (Item 17)</p>
Prerequisites	See page 2-15

This procedure checks the “sample rate” portion of the Delta Time Measurement Accuracy as listed in *Specifications*. The previous procedure, that checks the reference, see page 2-66, verified the “PPM” portion of the delta time specification.

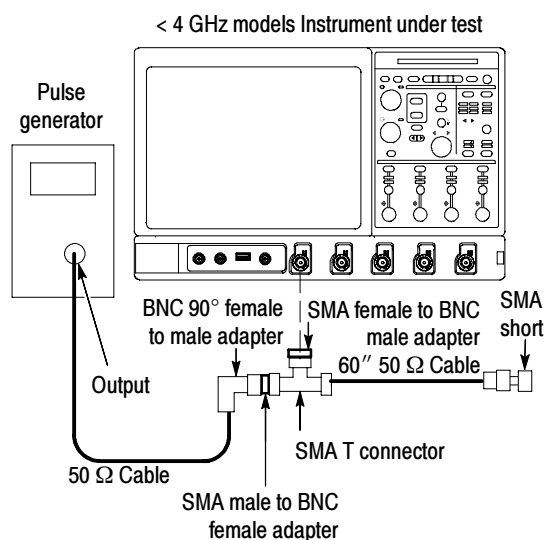

Figure 2-21: Delta time accuracy test hookup

1. Install the test hookup and preset the instrument controls:
 - a. Initialize the instrument: Press the **Default Setup** button.

b. *Hook up the pulse generator (see Figure 2-21 on page 2-69):*

- < 4 GHz models: Touch **Vertical**, select **Vertical Setup**, and then touch Termination **50 Ω**.
- Connect the pulse generator output to a **50 Ω** precision coaxial cable followed by a 90° right-angle female to male SMA adapter. The adapter is connected to one side of the female SMA T connector. The other side of the SMA T is connected to a 60 inch **50 Ω** coaxial cable. Connect the SMA short, to the remaining end of the cable. Now connect the male SMA T connector to **Ch 1** through an SMA female to BNC male adapter.
- Set the pulse generator output for a positive-going pulse with a rise-time as shown in Table 2-9 on page 2-70 for your instrument, and for the fastest possible rep rate (at least 1 kHz).
- Set the pulse generator output for about 500 mV. (This amplitude can be adjusted later to get a 5-division pulse on screen.)

c. *Modify the initialized front-panel control settings:*

- Power on the pulse generator.
- Readjust the Trigger **Level** knob so the trigger level is about 50% of the rising edge of the positive pulse.
- Press **Autoset**. You may see both positive and negative pulses. Adjust the Trigger **Level** knob so the trigger level is about 50% of the rising edge of the positive pulse.
- From the button bar, touch the **Horiz/Acq** button and select the **Acquisition** tab. Press the **RT** button to turn on Real Time Only.
- < 4 GHz models: Set the horizontal **SCALE** as indicated in Table 2-9.

Table 2-9: Delta time measurement settings

Instrument	Pulse generator rise and fall time range	Horizontal scale setting	Sample rate	Delta time accuracy limit
DPO7354	≤ 150 ps	10 ns/div	10 GS/s	≤ 6.0 ps
DPO7254	≤ 150 ps	10 ns/div	10 GS/s	≤ 6.0 ps
DPO7104	≤ 150 ps	10 ns/div	10 GS/s	≤ 6.0 ps
DPO7054	≤ 150 ps	20 ns/div	5 GS/s	≤ 12.0 ps

- Adjust instrument vertical scale and position as necessary to obtain at least **5 divisions** of the **positive** pulse.

NOTE. *If you have followed the procedure, you should have a 250 mV pulse displayed on screen. Later in this procedure you will set the instrument to measure the pulse width at the 150 mV level.*

If the pulse you supply to the instrument is not a 250 mV pulse, you may need to set the reference level (MidRef) to something other than 150 mV. Set the reference level near the center of the pulse, above any noise, and below any overshoot or ringing on the pulse.

d. *Set up for statistics measurements:*

- Press **Run/Stop** button to freeze the display.
- From the button bar, touch **Measure** and select the **Time** tab to bring up the Time Measurements menu.
- Touch the **Pos Width** button.
- Touch Setups **Statistics** and then touch **All**. Touch **Reset** to reset the statistics.
- Touch **Weight n=**. On the keypad press **1000**, then **Enter**. Touch **Setup**.
- Touch Setups **Ref Levs** and then touch **Absolute**.
- Touch **MidRef**. Using the keypad or multipurpose knobs, set the mid reference to **150 mV** and press Enter. Touch the **X (Close)** button.
- Press the **Run/Stop** button to start the acquisitions.
- Wait about 30 seconds.
- Press **Run/Stop** button to freeze the display.
- Read the Std Dev statistic measurement.
- The standard deviation (St Dev) measurement must be less than or equal to the Delta-time accuracy limit shown in Table 2-9 for your instrument.
- Enter the result for delta time on the test record.

e. *Repeat for all other channels:*

- Note the vertical scale setting of the channel just confirmed.
- Press the Vertical channel button for the channel just confirmed to remove the channel from display.
- Touch **Measure** and then **Clear All** to remove the measurement.

- Press the front-panel button that corresponds to the channel you are to confirm.
- Set vertical Scale to the setting noted in step e, first bullet.
- Press the Trigger **Source** button to toggle the source to the channel selected.
- < 4 GHz models: Touch **Vertical**, select **Vertical Setup**, and then touch Termination **50 Ω**.
- Move the test hookup to the channel you selected.
- Press **Run/Stop** button to start the display.
- Repeat step d.

2. *Disconnect all test equipment from the instrument.*

Trigger System Checks

These procedures check those characteristics that relate to the trigger system and are listed as checked in *Specifications*.

Check Time Qualified Trigger Accuracy

Equipment required	One sine wave generator (Item 9) One 2X attenuator (Item 26) One 50 Ω, precision coaxial cable (Item 4) One SMA male-to-female BNC adapter (Item 19)
Prerequisites	See page 2-15

1. *Install the test hookup and preset the instrument controls:*
 - a. *Initialize the instrument:* Press the **Default Setup** button.
 - b. *Modify the default setup:*
 - < 4 GHz models: Set the horizontal **Scale** to 2.5 ns.
 - ≥ 4 GHz models: Set the horizontal **Scale** to 2 ns.
 - < 4 GHz models: From the button bar, click the **Vertical** button; then click the Termination **50 Ω** button.

- c. *Hook up the test-signal source:* Connect the output of the sine wave generator to Ch 1 as shown in Figure 2-22.

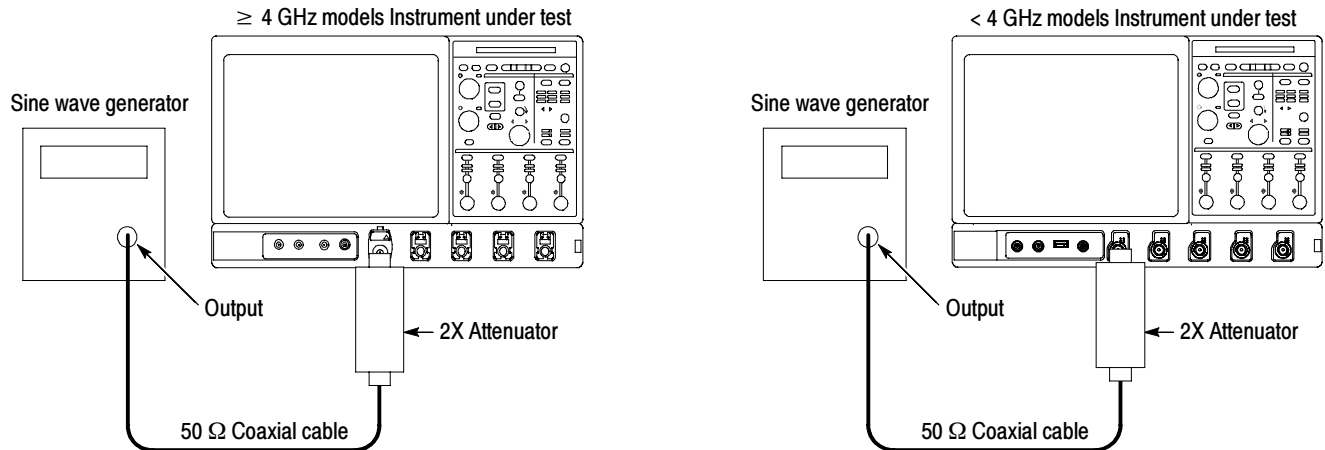

Figure 2-22: Initial test hookup

- d. *Set the trigger mode:* Press the Trigger Mode button to toggle it to Normal.

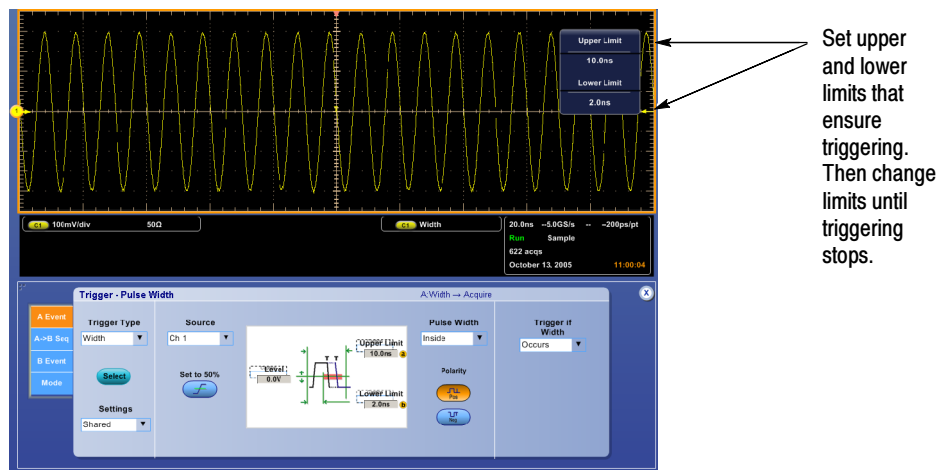

Figure 2-23: Measurement of time accuracy for pulse and glitch triggering

2. *Confirm the trigger system is within time-accuracy limits for time qualified trigger accuracy (time range <math>< 1 \mu\text{s}</math>):*

- a. *Set upper and lower limits that ensure triggering at 100 MHz:* See Figure 2-23.

- Press the front-panel **Advanced** button and select the **A Event** tab; then pull down on Trigger Type and select **Width** triggering.
 - Pull down Pulse Width and select **Inside** limits.
 - Touch **Upper Limit**. Use the keypad to set the upper limit to 10 ns.
 - Touch **Lower Limit**. Use the keypad to set the lower limit to 2 ns.
- b. *Display the test signal:*
- Set the Horizontal **Scale** to 20 ns.
 - Set the output of the sine wave generator for a 100 MHz, five-division sine wave on screen. Set the Vertical **Scale** to 20 mV (the waveform will overdrive the display).
 - Press **PUSH-SET 50%**.
- c. *Check against limits:* Do the following subparts in the order listed.
- While doing the following subparts, monitor the display (it will stop acquiring) and the front-panel light **Trig'd** (it will extinguish) to determine when triggering is lost.
 - ≥ 4 GHz models: Press the multipurpose knobs until Fine is on.
 - Use the multipurpose knob to *increase* the **Lower Limit** readout until triggering is lost.
 - CHECK that the **Lower Limit** readout, after the instrument stops triggering, is within the following limits:
 - < 4 GHz models: 3.5 ns to 6.5 ns
 - ≥ 4 GHz models: 4.77 ns to 5.23 ns
 - Enter the time on the test record.
 - Use the keypad to return the **Lower Limit** to 2 ns and reestablish triggering.
 - Touch **Upper Limit**; then use the multipurpose knob to slowly *decrease* the **Upper Limit** readout until triggering stops.
 - CHECK that the **Upper Limit** readout, after the instrument loses triggering, is within the following limits:
 - < 4 GHz models: 3.5 ns to 6.5 ns, inclusive
 - ≥ 4 GHz models: 4.77 ns to 5.23 ns, inclusive
 - Enter the time on the test record.
3. *Confirm the trigger system is within time-accuracy limits for pulse-glitch or pulse-width triggering (time range $\geq 1 \mu\text{s}$):*

- a. *Set upper and lower limits that ensure triggering at 250 kHz:*
 - Touch **Upper Limit**. Use the keypad to set the upper limit to 4 μ s.
 - Touch **Lower Limit**. Use the keypad to set the lower limit to 500 ns.
 - b. *Display the test signal:*
 - < 4 GHz models: Set the Horizontal **Scale** to 5 μ s.
 - \geq 4 GHz models: Set the Horizontal **Scale** to 4 μ s.
 - Set the Vertical **Scale** to 100 mV.
 - Set the output of the sine wave generator for a 250 kHz, five-division sine wave on screen. Set the Vertical **Scale** to 20 mV (the waveform will overdrive the display).
 - Press **PUSH-SET 50%**.
 - c. *Check against limits:* Do the following subparts in the order listed.
 - \geq 4 GHz models: Press the multipurpose knobs until Fine is on.
 - Use the multipurpose knob to *increase* the **Lower Limit** readout until triggering is lost.
 - CHECK that the **Lower Limit** readout, after the instrument stops triggering, is within the following limits:

< 4 GHz models:	1.9 μ s to 2.1 μ s, inclusive
\geq 4 GHz models:	1.9 μ s to 2.1 μ s, inclusive
 - Enter the time on the test record.
 - Use the keypad to return the **Lower Limit** to 500 ns and reestablish triggering.
 - Touch **Upper Limit**; then use the multipurpose knob to slowly *decrease* the **Upper Limit** readout until triggering stops.
 - CHECK that the **Upper Limit** readout, after the instrument loses triggering, is within the following limits:

< 4 GHz models:	1.9 μ s to 2.1 μ s, inclusive
\geq 4 GHz models:	1.9 μ s to 2.1 μ s, inclusive
 - Enter the time on the test record.
4. *Disconnect the hookup:* Disconnect the equipment from the instrument.

**Check Sensitivity, Edge
Trigger, DC Coupled**

Equipment required	One leveled sine wave generator (Item 9) Three precision 50 Ω coaxial cables (Item 21) Two SMA female to BNC male adapters (item 23) Three SMA female-to-female adapters (item 16) One 10X attenuator (Item 1) One power splitter (Item 11) Male N-to-BNC adapter (Item 14) One SMA adapter (Item 19) One 5X attenuator (Item 2) One 2X attenuator (Item 26) < 4 GHz models, one 50 Ω termination (item 3)
Prerequisites	See page 2-15.

NOTE. *The sine wave generator output amplitude must be leveled to within 0.35 dB of the reference frequency (10 MHz) through the trigger frequency being tested.*

Refer to the Sine Wave Generator Leveling Procedure on page 2-104 if your sine wave generator does not have automatic output amplitude leveling.

1. *Install the test hookup and preset the instrument controls:*
 - a. *Initialize the instrument:* Press the **Default Setup** button.
 - b. *Modify the initialized front-panel control settings:*
 - Set the Horizontal **Scale** to 20 ns.
 - < 4 GHz models: Touch **Vertical**, select **Vertical Setup**, and then touch Termination **50 Ω** .
 - Press the Trigger **Mode** button to toggle it to **Normal**.
 - From the button bar, touch **Horiz/Acq** and select the **Acquisition** tab.
 - Touch **Average** and set the number of averages to **16**.
 - Touch the **Equivalent ET** button.

c. *Hook up the test-signal source:*

- Connect the signal output of the generator to a power splitter. Connect one output of the power splitter to **Ch 1** as shown in Figure 2-24. Connect the other output of the power splitter to the **Aux Input** as shown in Figure 2-24.

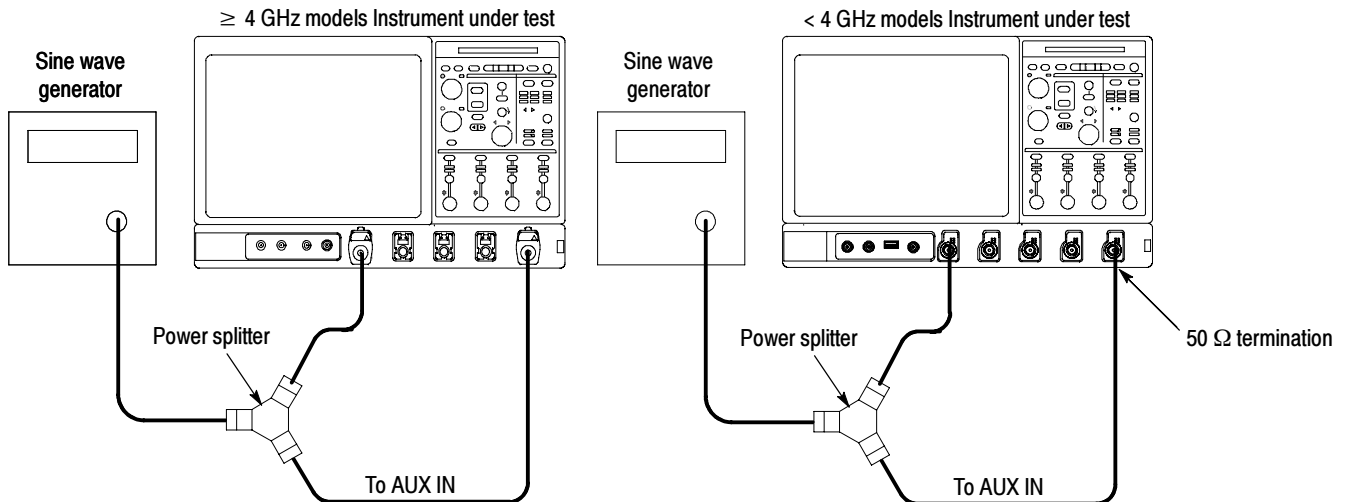

Figure 2-24: Initial test hookup

2. *Confirm the trigger system is within sensitivity limits (50 MHz):*

a. *Display the test signal:*

- Set the generator frequency to 50 MHz.
- From the button bar, touch **Measure**.
- Touch Setup **Ref Levs**; then touch the **Min-Max** button.
- Touch the **Setup** button and select the **Ampl** tab; then touch the **Amplitude** button.
- Touch the X (close) button.
- Press **Push-Set 50%**.

- Set the generator amplitude on screen as follows:

≥ 4 GHz models	4 divisions
< 4 GHz models	7 divisions

 - Now fine adjust the generator output until the **Ch 1 Amplitude** readout indicates the amplitude is as follows (Readout may fluctuate):

≥ 4 GHz models	400 mV
< 4 GHz models	700 mV

 - Disconnect the 50 Ω precision coaxial cable at **Ch 1** and reconnect it to **Ch 1** through a 10X attenuator.
- b.** *Check the A trigger system for stable triggering at limits:*
- Read the following definition: A stable trigger is one that is consistent; that is, one that results in a uniform, regular display triggered on the selected slope (positive or negative). This display should *not* have its trigger point switching between opposite slopes, nor should it roll across the screen. At horizontal scale settings of 2 ms/division and faster, **Trig'd** will remain constantly lighted. It will flash for slower settings.
 - Press the Trigger **Slope** button to select the positive slope.
 - Adjust the Trigger **Level** knob so that there is a stable trigger. CHECK that the trigger is stable for the test waveform on the positive slope.
 - Press the Trigger **Slope** button to select the negative slope. Adjust the Trigger **Level** knob so that there is a stable trigger.
 - CHECK that the trigger is stable for the test waveform on the negative slope.
 - Enter pass or fail in the test record.
 - Leave the trigger system triggered on the positive slope of the waveform before continuing to the next step.

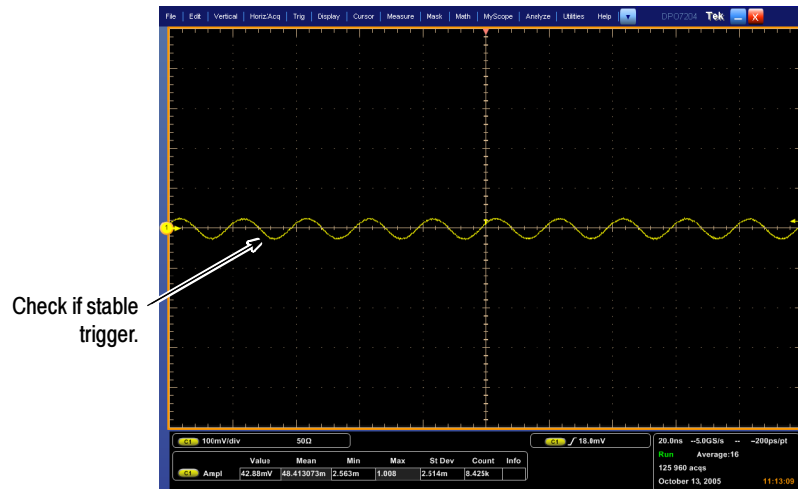

Figure 2-25: Measurement of trigger sensitivity - 50 MHz results shown

- c. ≥ 4 GHz models: *Check B trigger system for stable triggering at limits:*
Do the following subparts in the order listed.
- From the button bar touch **Trig**, select the **A Event** tab, and set the **Source** to Line.
 - Select the **A->B Seq** tab, and touch the A then B **Trig After Time** button.
 - Select the **B Event** tab, and touch the **Set To 50%** button.
 - CHECK that a stable trigger is obtained for the test waveform for both the positive and negative slopes of the waveform. Use the **Trigger Level** knob to stabilize the Main trigger. Touch **Level** and use the keypad or the multipurpose knob/Fine button to stabilize the Delayed trigger. Touch one of the Slope buttons to switch between trigger slopes. See Figure 2-25 on page 2-79.
 - Enter pass or fail in the test record.
 - Leave the Delayed trigger system triggered on the positive slope of the waveform before continuing to the next step. Also, return to the main trigger: select the **A->B Seq** tab and touch the A->B Sequence **A Only** button. Then select the **A Event** tab.
 - Select the **A Event** tab, and set the **Source** to CH1.
 - Press the X (Close button).

3. *Confirm the AUX Trigger input (at 50 MHz):*

a. *Display the test signal:*

- Remove the 10X attenuator and reconnect the cable to **Ch 1**.
- Set the signal amplitude as follows: **2.5 divisions**
- Now fine adjust the generator output until the **Ch 1 Amplitude** readout indicates the amplitude is as follows (Readout may fluctuate): **250 mV**

b. *Check the AUX trigger source for stable triggering at limits:* Do the following in the order listed.

- Use the definition for stable trigger from step 2b.
- Press the Trigger **Source** button to toggle it to **Aux**.
- Press **Push-Set 50%**.
- CHECK that a stable trigger is obtained for the test waveform on both the positive and negative slopes. Press the Trigger **Slope** button to switch between trigger slopes. Use the Trigger **Level** knob to stabilize the trigger if required.
- Enter pass or fail in the test record.
- Leave the trigger system triggered on the positive slope of the waveform before proceeding to the next check.
- Press the Trigger **Source** button to toggle it to **Ch 1**.

4. *Confirm that the A trigger system is within sensitivity limits (full bandwidth):*

a. *Set the Horizontal Scale:* Set the Horizontal **Scale** to 200 ps.

b. *Display the test signal:*

- Set the generator frequency to full bandwidth as follows:

≥ 4 GHz models	4 GHz
DPO7354	3.5 GHz
DPO7254	2.5 GHz
DPO7104	1 GHz
DPO7054	500 MHz

- Set the generator amplitude on screen as follows:

≥ 4 GHz models	2 divisions
DPO7354	5 divisions
DPO7254	6 divisions
DPO7104	6 divisions
DPO7054	6 divisions

 - Now fine adjust the generator output until the **Ch 1 Amplitude** readout indicates the amplitude is as follows (Readout may fluctuate):

≥ 4 GHz models	200 mV
DPO7354	500 mV
DPO7254	600 mV
DPO7104	600 mV
DPO7054	600 mV

 - Disconnect the cable at **Ch 1** and reconnect it to **Ch 1** through an attenuator:

≥ 4 GHz models	2X
DPO7354	2X
DPO7254	5X
DPO7104	5X
DPO7054	5X

 - Check that a stable trigger is obtained.
- c. Repeat step 2, substep b and c for the full bandwidth selected.

Table 2- 10: Trigger settings for ≥ 4 GHz models

Generator amplitude	Generator frequency		Horizontal scale
	A trigger	B trigger	
	10 MHz		200 ns
150 mV	6 GHz	6 GHz	200 ps
200 mV	8 GHz	NA	200 ps
500 mV	11 GHz	9 GHz	200 ps

- d. ≥ 4 GHz models: *Display the test signal:*
- Remove the attenuator
 - Set the generator frequency to 10 MHz. Set the Horizontal SCALE as indicated in Table 2-10.
 - Fine adjust the generator output until the **Ch 1 Amplitude** readout indicates the amplitude listed in Table 2-10 for a frequency not yet checked.
 - Set the generator frequency to the frequency in Table 2-10 that corresponds to the amplitude just set. Set the Horizontal **SCALE** as indicated in Table 2-10.
 - Check that a stable trigger is obtained.
 - Read the following definition: A stable trigger is one where the **Trig'd** LED will remain constantly lighted.
 - Press the Trigger **Slope** button to select the positive slope.
 - Adjust the Trigger **Level** knob so that there is a stable trigger. CHECK that the trigger is stable.
 - Press the Trigger **Slope** button to select the negative slope. Adjust the Trigger **Level** knob so that there is a stable trigger.
 - CHECK that the trigger is stable.
 - Enter pass or fail in the test record.
 - Leave the trigger system triggered on the positive slope of the waveform before continuing to the next step.
 - From the button bar touch **Trig**, select the **A Event** tab, and set the **Source** to Line.
 - If the generator frequency is different for the B trigger, set the generator frequency to the frequency in Table 2-10 that corresponds to the amplitude in Table 2-10.
 - From the button bar touch **Trig**, select the **A->B Seq** tab, and touch the A then B **Trig After Time** button.
 - Select the **B Event** tab, and touch the **Set To 50%** button.

- CHECK that a stable trigger is obtained for the test waveform for both the positive and negative slopes of the waveform. Use the **Trigger Level** knob to stabilize the Main trigger. Touch **Level** and use the keypad or the multipurpose knob/Fine button to stabilize the Delayed trigger. Touch one of the Slope buttons to switch between trigger slopes. See Figure 2-25 on page 2-79.
 - Enter pass or fail in the test record.
 - Leave the B trigger system triggered on the positive slope of the waveform before continuing to the next step. Also, return to the A trigger: select the **A->B Seq** tab and touch the **A->B Sequence A Only** button. Then select the **A Event** tab.
 - From the button bar touch **Trig**, select the **A Event** tab, and set the **Source** to CH1.
 - Press the X (Close button).
- e. ≥ 4 GHz models: Repeat step 4, substep d until each frequency listed in Table 2-10 on page 2-81 is checked.
- f. *Display the test signal (Aux trigger at bandwidth):*
- Set the Horizontal Scale to 1 ns.
 - < 4 GHz models: Remove the attenuator and reconnect the cable to **Ch 1**.
 - ≥ 4 GHz models: Reconnect the cable to **Ch 1**.
 - Set the generator frequency to full bandwidth as follows:

≥ 4 GHz models	1 GHz
< 4 GHz models	250 MHz
 - Set the generator amplitude on screen as follows:

≥ 4 GHz models	7 divisions
< 4 GHz models	7 divisions
 - Now fine adjust the generator output until the **Ch 1 Amplitude** readout indicates the amplitude is as follows (Readout may fluctuate):

≥ 4 GHz models	700 mV
< 4 GHz models	700 mV

- Disconnect the cable at **Aux In** and reconnect it to **Aux In** through an attenuator:

≥ 4 GHz models	2X
< 4 GHz models	2X

- g. Repeat step 3, substeps b only, for the full bandwidth selected.

NOTE. You just checked the trigger sensitivity. If desired, you may repeat steps 1 through 4c for the other channels (Ch 2, Ch 3, and Ch 4).

- 5. *Disconnect the hookup:* Disconnect the equipment from Aux In and the channel last tested.

Output Signal Checks

The procedure that follows checks those characteristics of the output signals that are listed as checked under *Warranted Characteristics in Specifications*.

Check Aux Trigger Out

Equipment required	One precision 50 Ω coaxial cables (Item 4)
Prerequisites	See page 2-15. Also, the instrument must have passed <i>Check DC Voltage Measurement Accuracy</i> on page 2-37.

- 1. *Install the test hookup and preset the instrument controls:*

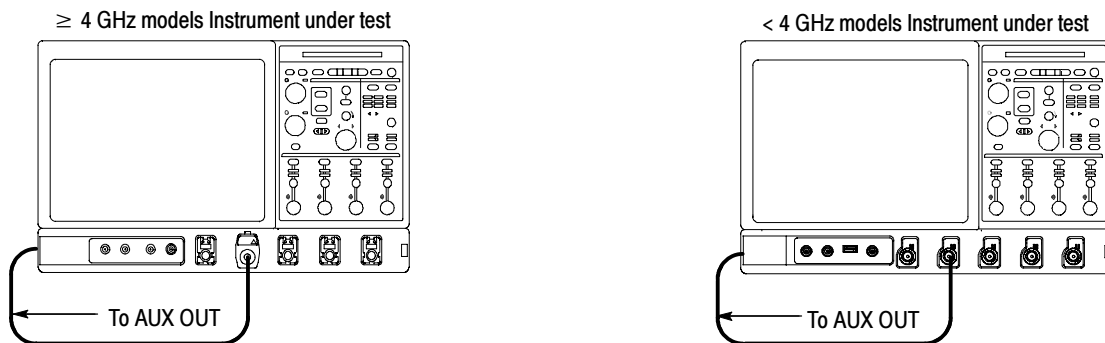

Figure 2- 26: Initial test hookup

- a. *Hook up test-signal source (See Figure 2-26):* Connect the **Aux Out** to **Ch 2** through a 50 Ω precision cable and an adapter.
 - b. *Initialize the instrument:* Press the **Default Setup** button.
 - c. *Modify the initialized front-panel control settings:*
 - Press the Vertical **Ch 1** button to toggle it off.
 - Set the Horizontal **Scale** to 200 μ s.
 - From the button bar, touch **Horiz/Acq** and select the **Acquisition** tab.
 - Touch **Average** and set the number of averages to **64**.
 - Touch the **X** (close) button.
2. *Confirm Aux Out is within limits for logic levels:*
 - a. *Display the test signal:*
 - Press the Vertical **Ch 2** button to display that channel.
 - < 4 GHz models: Touch **Vertical**, select **Vertical Setup**, and then touch Termination **50 Ω** .
 - Set the Vertical **Scale** to 500 mV.
 - Use the Vertical **Position** knob to center the display on screen.
 - b. *Measure logic levels:*
 - From the button bar, touch **Measure** and select the **Ampl** tab.
 - Touch the **High** and **Low** buttons.
 - Touch the **X** (close) button.
 - c. *Check Aux Out output against limits:* CHECK that the **Ch 2 High** readout is ≥ 1.0 volt and that the **Ch 2 Low** readout ≤ 0.25 volts. See Figure 2-27.
 3. *Disconnect the hookup:* Disconnect the test setup from the inputs and outputs.



Figure 2- 27: Measurement of trigger out limits

Check Probe Compensation or Fast Edge Output

Equipment required	One BNC to Minigrabber adapter (item 18) One precision 50 Ω coaxial cable (Item 21) One DC calibration generator (Item 6) One adapter (Item 19)
Prerequisites	See page 2-15. Also, the instrument must have passed <i>Check Timebase and Delay Time Accuracy and Reference</i> on page 2-66.

1. *Install the test hookup and preset the instrument controls:*
 - a. *Hook up test-signal:* See Figure 2-28.

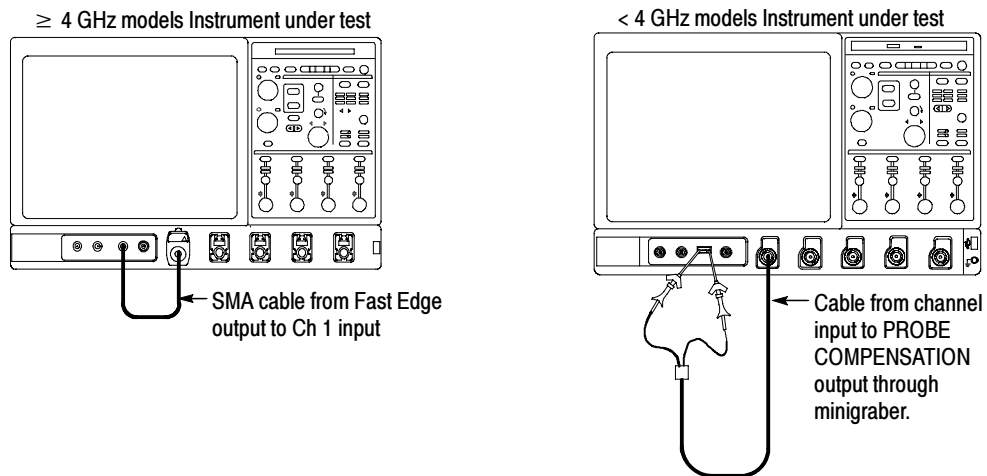

Figure 2-28: Initial test hookup

- b. *Initialize the instrument:* Press the **Default Setup** button.
- c. *Modify the initialized front-panel control settings:*
 - Set the **Vertical Scale** to 200 mV.
 - Set the **Horizontal Scale** to 200 μ s.
 - Press **Push-Set 50%**.
 - Use the **Vertical Position** knob to center the display on screen.
 - From the button bar, touch **Horiz/Acq** and select the **Acquisition** tab.
 - Touch **Average** and set the number of averages to **128**.

2. Confirm the Probe Compensator signal:



Figure 2-29: Measurement of probe compensator frequency

a. Save the probe compensation signal in reference memory:

- From the menu bar, touch **File; Save As . . . , Waveform**, and then **Ref 1**.
- Touch the **Save** button to save the probe compensation signal in reference 1.
- < 4 GHz models: Disconnect the signal from **Ch 1** and the probe compensation connector.
- ≥ 4 GHz models: Disconnect the signal from **Ch 1** and the Fast Edge connector.
- Touch **File; Recall . . . , Waveform**, and then select the file name.
- Touch the **Recall** button to recall the probe compensation signal to the display.

b. Hook up the DC standard source:

- Set the output of a DC calibration generator to off or 0 volts.
- Connect the output of a DC calibration generator to **Ch 1**. See Figure 2-30.

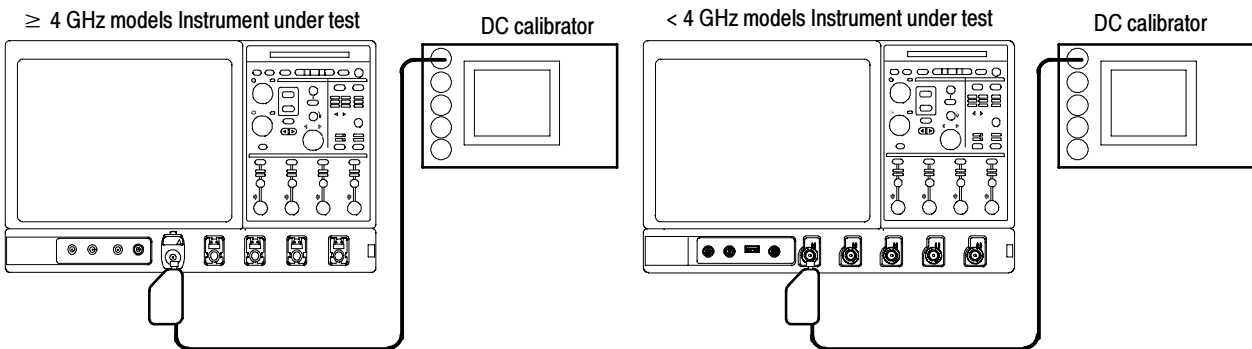

Figure 2-30: Subsequent test hookup

c. *Measure amplitude of the probe compensation signal:*

- From the button bar, touch **Horiz/Acq** and select the **Acquisition** tab.
 - Touch **Average** and set the number of averages to **16** using the keypad or the multipurpose knob.
 - Adjust the output of the DC calibration generator until it precisely overlaps the top (upper) level of the stored probe compensation signal.
 - Record the setting of the DC generator.
 - Adjust the output of the DC calibration generator until it precisely overlaps the base (lower) level of the stored probe compensation signal.
 - Record the setting of the DC generator.
- d.** Press the **X** (close) button to remove the menus from the display. See Figure 2-31.

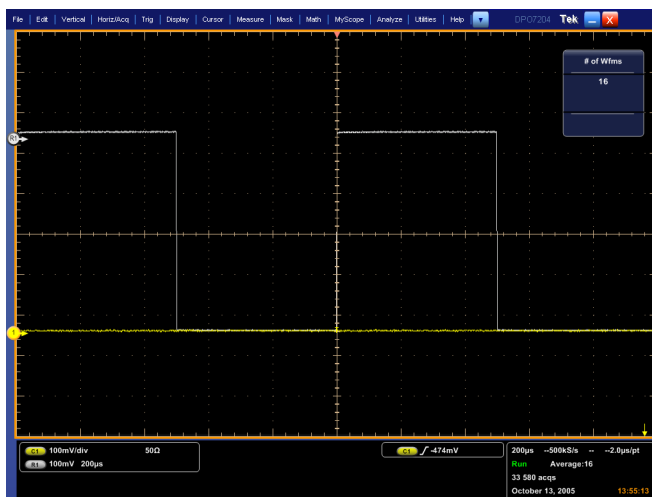

Figure 2-31: Measurement of probe compensator amplitude

e. Check against limits:

- Subtract the value just obtained (base level) from that obtained previously (top level).
- CHECK that the difference obtained is within limits as follows:

≥ 4 GHz models	352 mV to 528 mV
< 4 GHz models	985 mV to 1015 mV
- Enter voltage difference on test record.

3. Disconnect the hookup: Disconnect the equipment from **Ch 1**.

Serial Trigger Checks (Optional on Some Models)

These procedures check those characteristics that relate to the serial trigger system and are listed as checked in *Specifications*.

Check Serial Trigger Baud Rate Limits

Equipment required	One precision 50 Ω coaxial cable (Item 4) One sine-wave generator (Item 9) One adapter (Item 19)
Prerequisites	See page 2-15. Also, the instrument must have passed <i>Check DC Voltage Measurement Accuracy</i> on page 2-37.

1. *Install the test hookup and preset the instrument controls:*

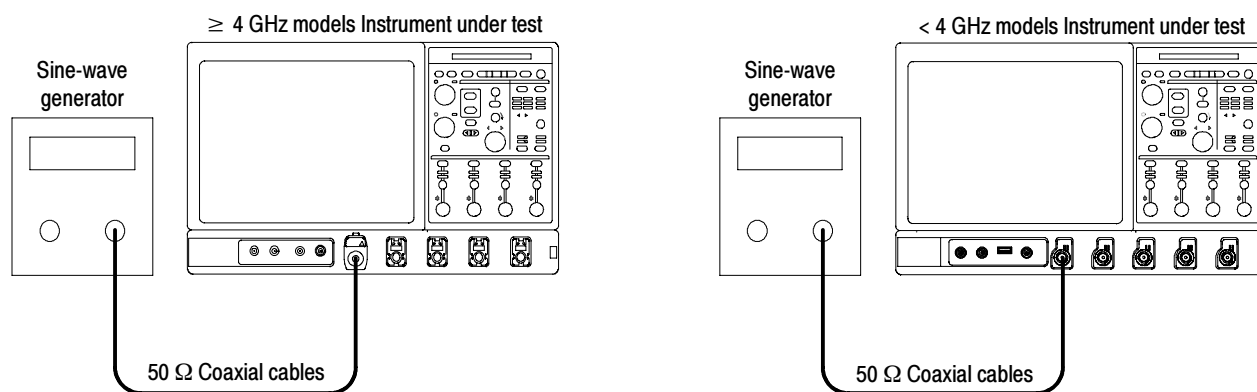

Figure 2-32: Initial test hookup

- a. *Hook Up the test-signal source (see Figure 2-32):*
 - Connect the sine wave output of the sine-wave generator through a 50 Ω precision coaxial cable to Ch 1 through an adapter.
 - Set the sine-wave generator to output a 416 MHz sine wave.
- b. *Initialize the instrument:* Press the **Default Setup** button.
- c. *Modify the initialized front-panel control settings:*
 - Set the vertical **Scale** to 50 mV per division.
 - < 4 GHz models: Touch **Vertical**, select **Vertical Setup**, and then touch Termination **50 Ω** .
 - Set the horizontal **Scale** to 1 ns per division.

- Adjust the sine-wave generator output for 4 divisions of amplitude centered on the display.
- Adjust the trigger **Level** to trigger at 25% (-1 division) on the sine wave.

Table 2- 11: Serial pattern data

Serial pattern data	Trigger location
B6DB 6DB6 DB6D B6DB ₁₆	One UI before the 0
6DB6 DB6D B6DB 6DB6 ₁₆	At the 0
DB6D B6DB 6DB6 DB6D ₁₆	One UI after the 0

2. *Verify that the signal path can do isolated 0 and pattern matching circuits can do isolated 1:*
 - a. From the button bar, touch **Cursors** and then the **Setup** button. If using the menu bar, touch **Cursors** and then select **Cursor Setup**. Touch the **Cursor** button to toggle it on and display the cursors.
 - b. Set the Tracking Mode to **Tracking**.
 - c. Touch the **X** (close) button.
 - d. Adjust the cursors until the Δt readout equals 800 ps (one unit interval).
 - e. From the button bar, touch **Trig**, select the **A Event** tab, and touch the **Select** button.
 - f. Touch the **Serial** button, set Coding to NRZ, and then set the Standard to **GB Ethernet**.
 - g. Touch the **Edit** button.
 - h. Set the Format to **Hex** and then touch the **Clear** button.
 - i. Enter data into the Serial Pattern Data field for one of the settings in Table 2-11 that is not yet checked. (Start with the first setting listed.)
 - j. Touch **Enter**.
 - k. Center Cursor 2 in the low of the waveform just to the right of the center graticule line (see Figure 2-33 on page 2-93).
 - l. Verify that the instrument triggers one Unit Interval (UI, one baud divided by the bit period) before the 0 in the input signal (see Figure 2-33 on page 2-93). The absolute value of the T1 cursor readout must be ≤ 200 ps. Enter pass or fail in the test record.

- m. Touch the **Edit** and then the **Clear** button.
- n. Enter data into Serial Pattern Data field for the next setting in Table 2-11 that is not yet checked.
- o. Touch **Enter**.
- p. Center the Cursor 1 in the low of the waveform nearest the center graticule line (see Figure 2-33 on page 2-93).

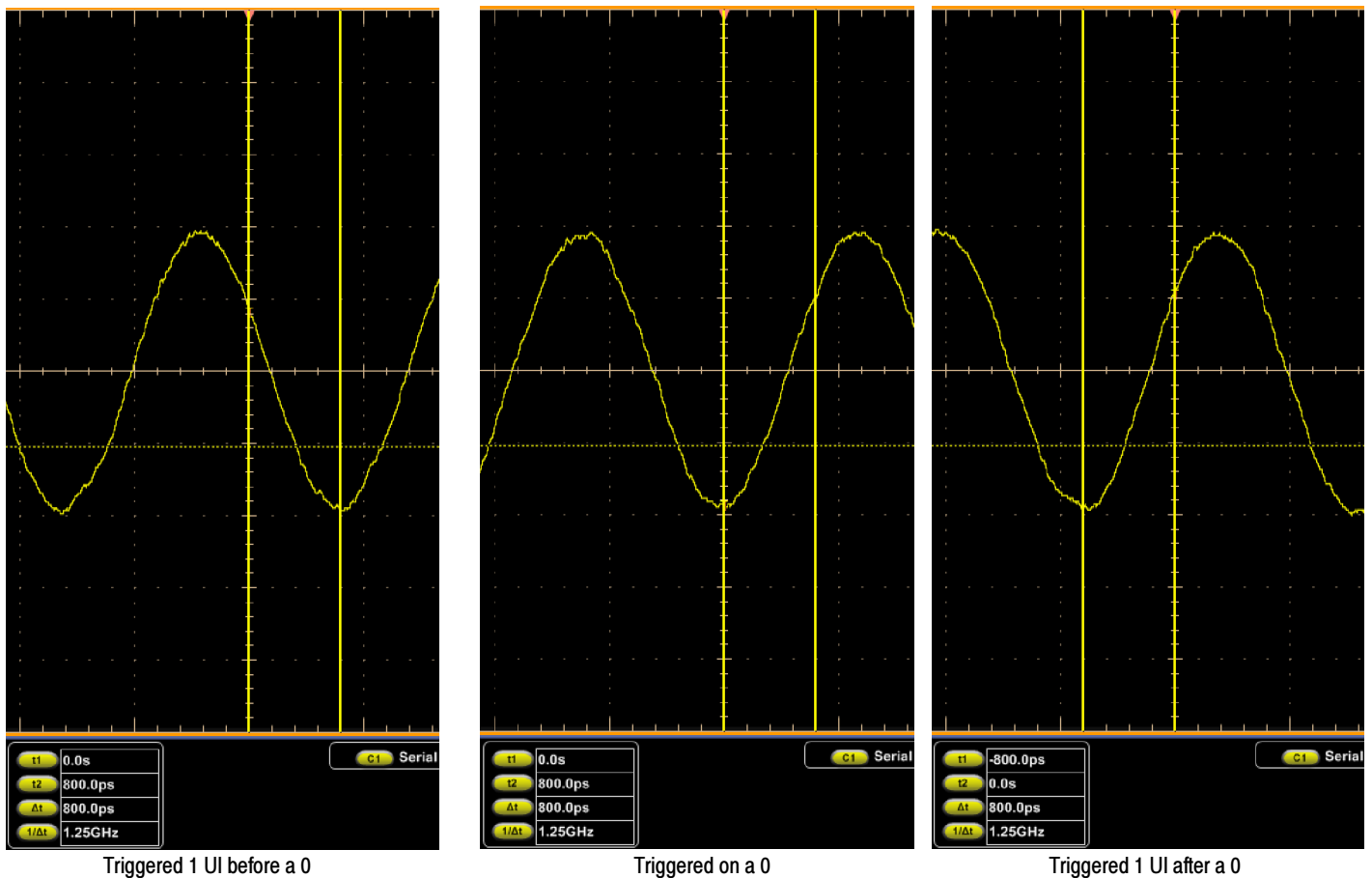

Figure 2-33: Isolated 0 triggering

- q. Verify that the instrument triggers at the 0 in the input signal (see Figure 2-33 on page 2-93). The absolute value of the T1 cursor readout must be ≤ 200 ps. Enter pass or fail in the test record.
- r. Touch the **Edit** and then the **Clear** button.
- s. Enter data into Serial Pattern Data field for the next setting in Table 2-11 that is not yet checked.

- t. Touch **Enter**.
- u. Center Cursor 1 in the low of the waveform just to the left of the center graticule line (see Figure 2-33 on page 2-93).
- v. Verify that the instrument triggers one Unit Interval (UI) after the 0 in the input signal (see Figure 2-33 on page 2-93). The absolute value of the T2 cursor readout must be ≤ 200 ps. Enter pass or fail in the test record.

Table 2-12: Word recognizer data

Serial pattern data	Trigger location
4924 9249 2492 4924 ₁₆	One UI before the 1
9249 2492 4924 9249 ₁₆	At the 1
2492 4924 9249 2492 ₁₆	One UI after the 1

3. *Verify that the serial path and pattern matching circuits can do isolated 1s:*
 - a. Adjust the trigger **Level** to trigger at 75% (+1 division) on the sine wave.
 - b. Touch the **Edit** and then the **Clear** button.
 - c. Enter data into the Serial Pattern Data field for one of the settings in Table 2-12 that is not yet checked. (Start with the first setting listed.)
 - d. Touch **Enter**.
 - e. Center Cursor 2 in the high of the waveform just to the right of the center graticule line (see Figure 2-34 on page 2-96).
 - f. Verify that the instrument triggers one Unit Interval (UI) before the 1 in the input signal (see Figure 2-34 on page 2-96). The absolute value of the T1 cursor readout must be ≤ 200 ps. Enter pass or fail in the test record.
 - g. Touch the **Edit** and then the **Clear** button.
 - h. Enter data into the Serial Pattern Data field for the next setting in Table 2-12 that is not yet checked.
 - i. Touch **Enter**.
 - j. Center the Cursor 1 in the waveform high nearest the center graticule line (see Figure 2-34 on page 2-96).

- k. Verify that the instrument triggers at the 1 in the input signal (see Figure 2-34 on page 2-96). The absolute value of the T1 cursor readout must be ≤ 200 ps. Enter pass or fail in the test record.
- l. Touch the **Edit** and then the **Clear** button.
- m. Enter data into the Serial Pattern Data field for the next setting in Table 2-12 that is not yet checked.
- n. Touch **Enter**.
- o. Center Cursor 1 in the high of the waveform just to the left of the center graticule line (see Figure 2-34 on page 2-96).
- p. Verify that the instrument triggers one Unit Interval (UI) after the 1 in the input signal (see Figure 2-34 on page 2-96). The absolute value of the T2 cursor readout must be ≤ 200 ps. Enter pass or fail in the test record.

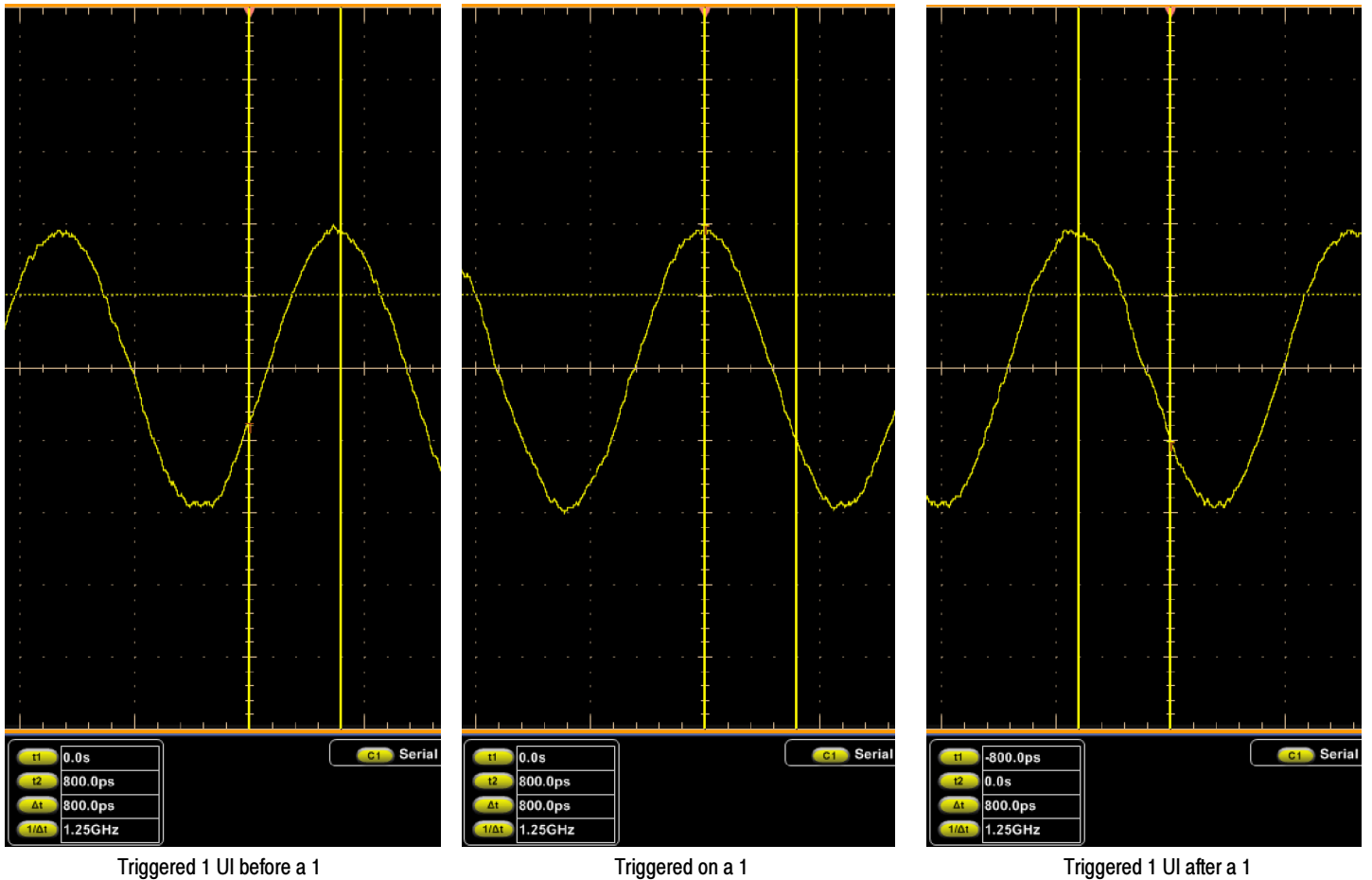

Figure 2-34: Isolated 1 triggering

**Check Serial Trigger Baud Rate Limits
(≥ 4 GHz models Only)**

Equipment required	One SMA cable (Item 28) Data time generator (Item 30) One TCA-BNC or TCA-292 mm adapter (item 19)
Prerequisites	The oscilloscope must meet the prerequisites listed on page 2-15. Also, the oscilloscope must have passed <i>Check DC Voltage Measurement Accuracy</i> on page 2-37.

1. *Install the test hookup and preset the instrument controls:*

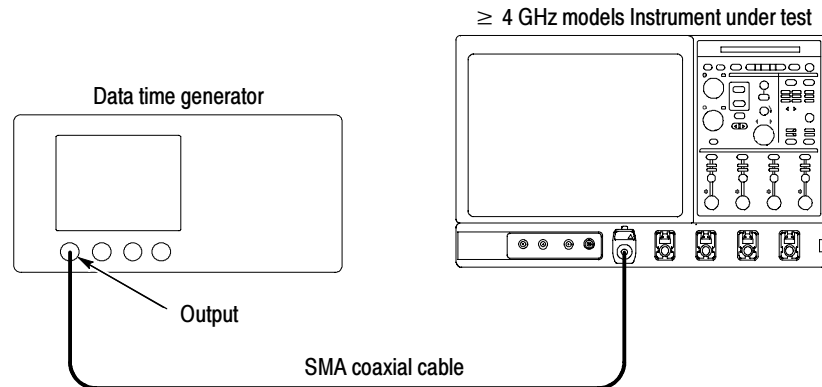

Figure 2-35: Initial test hookup

- a. *Hook Up the test-signal source (see Figure 2-35):*
 - Connect the output of the data time generator through a SMA precision coaxial cable to CH 1 through an adapter.
 - Set the data time generator output 3.125 GHz.
 - Load the CJTPAT serial streams on the data generator, see Table 2-13 on page 2-98. Other data streams may be used, but they may not match the serial patterns listed on Table 2-14 on page 2-98.
- b. *Initialize the instrument:* Press the **DEFAULT SETUP** button.

- c. Modify the initialized front-panel control settings:
 - Set the vertical **SCALE** to 200 mV/div \approx 5 divisions signal.
 - Position vertically on screen.
 - < 4 GHz models: Set the horizontal **SCALE** to 1.25 ns per division.
 - \geq 4 GHz models: Set the horizontal **SCALE** to 1.0 ns per division.
 - Press **PUSH TO SET 50%** button.
 - Repeat the previous bullet (**PUSH TO SET 50%** button) if pattern does not lock within a few seconds.

Table 2- 13: Generator serial streams

CJTPAT	Pattern	Repeat	Total
3E AA 2A AA AA	5	6	30
3E AA A6 A5 A9	5	1	5
87 1E 38 71 E3	5	41	205
87 1E 38 70 BC 78 F4 AA AA AA	10	1	10
AA AA AA AA AA	5	12	60
AA A1 55 55 E3 87 1E 38 71 E1	10	1	10
AB 9C 96 86 E6	5	1	5
C1 6A AA 9A A6	5	1	5

Table 2- 14: Serial pattern data

Name	Serial pattern data	Trigger location
K28.5 RD-	00 1111 1010	Last bit
D21.5 RD \pm	10 1010 1010	Last bit
D30.3 RD-	01 1110 0011	Last bit
K28.5 RD+	11 0000 0101	Last bit

2. *Verify that the instrument can trigger on the pattern listed in Table 2-14:*
 - a. From the toolbar, touch **Trig** and select the **A Event** tab, touch the **Select** button from the Trigger Type.
 - b. Touch the **Serial** button and then select **S8b10b** from the Coding drop down.

Check Serial Trigger Clock Recovery Range

Equipment required	One precision 50 Ω coaxial cable (Item 4) One sine-wave generator (Item 9) One adapter (Item 19)
Prerequisites	See page 2-15. Also, the instrument must have passed <i>Check DC Voltage Measurement Accuracy</i> on page 2-37.

1. Install the test hookup and preset the instrument controls:

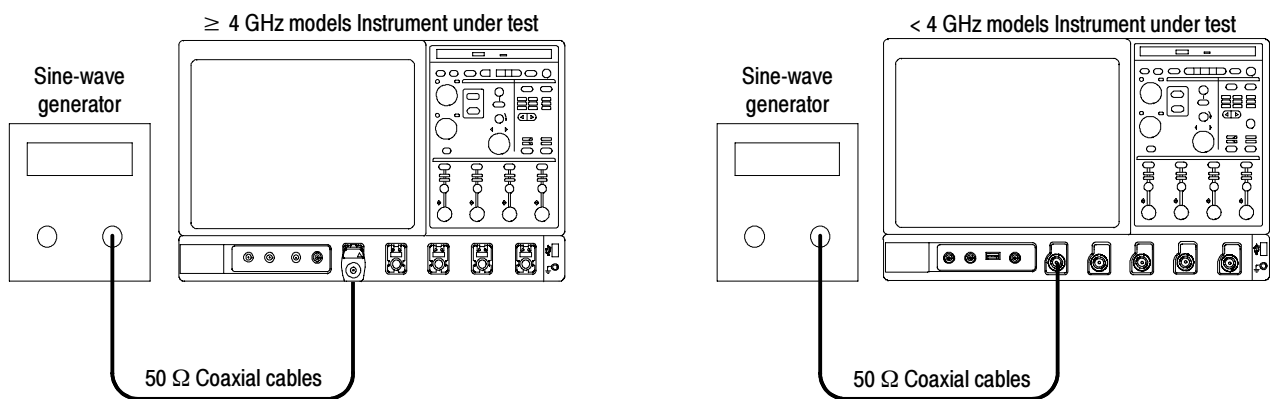

Figure 2-36: Initial test hookup

- a. *Hook up test-signal source 1 (See Figure 2-36):*
 - Connect the sine wave output of the sine-wave generator through a 50 Ω precision coaxial cable to Ch 1 through an adapter.
 - Set the sine-wave generator to output a 1.5625 GHz sine wave.
- b. *Initialize the instrument:* Press the **Default Setup** button.
- c. *Modify the initialized front-panel control settings:*
 - Press the **Vertical Scale** to 50 mV per division.
 - < 4 GHz models: Touch **Vertical**, select **Vertical Setup**, and then touch **Termination 50 Ω** .
 - Set the horizontal **Scale** to 200 ps per division.
 - From the button bar, touch the **Display** button.
 - Set the Display Style to **Dots**.

-
- Set the Display Persistence to **Variable**, and set the persist Time to **3.0 s**.
 - Touch the **X** (close) button.
 - Adjust the sine-wave generator output for 8 divisions of amplitude.
 - From the button bar, touch **Trig** and select the **A Event** tab.
 - Touch the **Select** button.
 - Touch the **Comm** button. Set **Source** to Ch1, **Type** to R Clk, and **Coding** to NRZ.
2. *Verify the clock recovery at frequency:*
- a. From the button bar, touch **Trig** and select the **A Event** tab.
 - b. Set the sine-wave generator to output one of the input frequencies in Table 2-15 (on page 2-102) that is not yet checked. (Start with the first setting listed.)
 - c. Set the instrument Bit Rate to the Recovered clock Baud rate listed in the table for the current input frequency.

NOTE. *The instrument will attempt to acquire lock once. If the input data is disrupted, removed, or heavily distorted, the instrument may not acquire lock or may lose lock. If the recovered clock is not locked to the incoming data, the waveform display will not be stable (see Figure 2-37 on page 2-103). Once the input data is available, press the PUSH SET TO 50% knob to force the instrument to acquire lock again.*

- d. Press **PUSH-SET 50%**.

NOTE. *As the input frequency is lowered, adjust the Horizontal SCALE to maintain about 3 to 5 eyes across the display.*

- e. Verify that lock is acquired as in Figure 2-37 on page 2-103.
 - f. Repeat substeps b through d for each input frequency and Baud rate listed in Table 2-15 (on page 2-102).
 - g. If all tests pass, enter passed in the test record.
3. *Disconnect the hookup:* Disconnect the equipment from the instrument.

Table 2- 15: Clock recovery input frequencies and baud rates

Input frequency	Recovered clock Baud rate
1.5625 GHz (\geq 4 GHz models)	3125 Mbaud
781.25MHz (\geq 4 GHz models)	3125 Mbaud
781.25 MHz (\geq 4 GHz models)	2968.8 Mbaud
742.19 MHz (\geq 4 GHz models)	3125 Mbaud
600 MHz (\geq 4 GHz models)	2400 Mbaud
575.00 MHz (\geq 4 GHz models)	2300 Mbaud
575.00 MHz (\geq 4 GHz models)	2185 Mbaud
546.25 MHz (\geq 4 GHz models)	2300 Mbaud
390.63 MHz	1.5625 Gbaud
388.13 MHz	1.5525 Gbaud

Recovered clock locked
(1.5625 GHz)

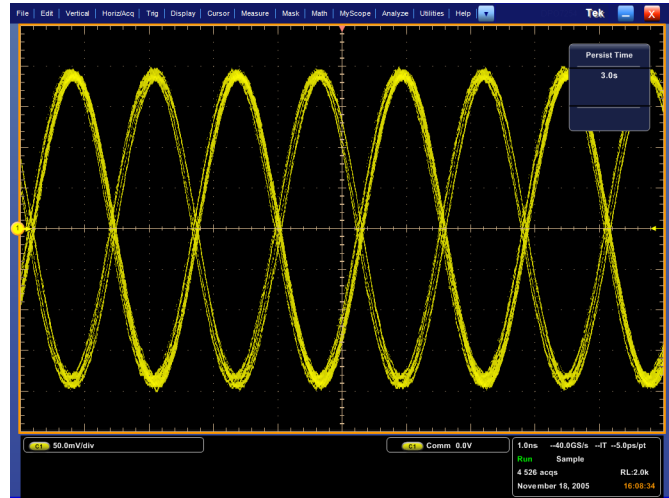

Recovered clock locked
(All frequencies except
1.5625 GHz)

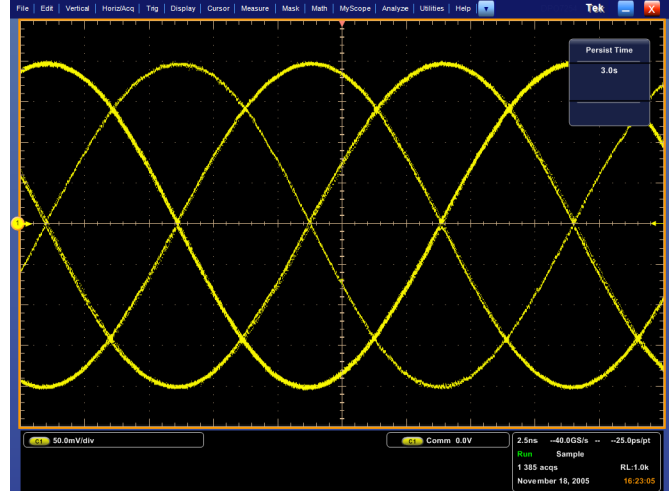

A possible display with the
recovered clock not locked

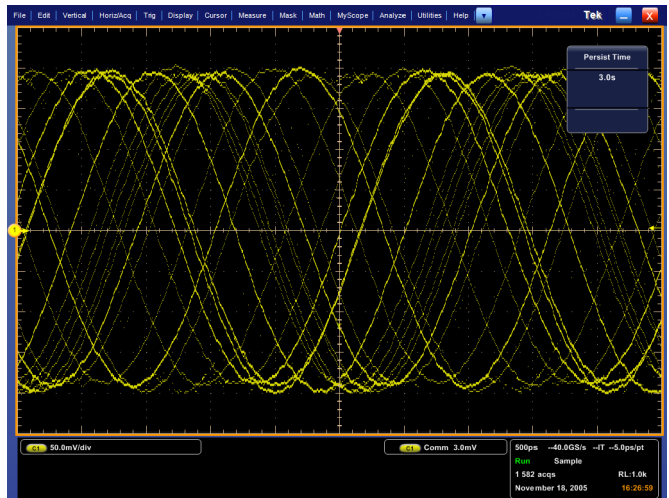

Figure 2-37: Clock recovery

Sine Wave Generator Leveling Procedure

Some procedures in this manual require a sine wave generator to produce the necessary test signals. If you do not have a leveled sine wave generator, use one of the following procedures to level the output amplitude of your sine wave generator.

Equipment required	Sine wave generator (Item 9) Meter, power and sensor (Item 10) Power splitter (Item 11) 50 Ω precision cable 2.92 mm male-to-female (Item 12) One K male-to-male adapter (Item 13)
Prerequisites	See page 2-15

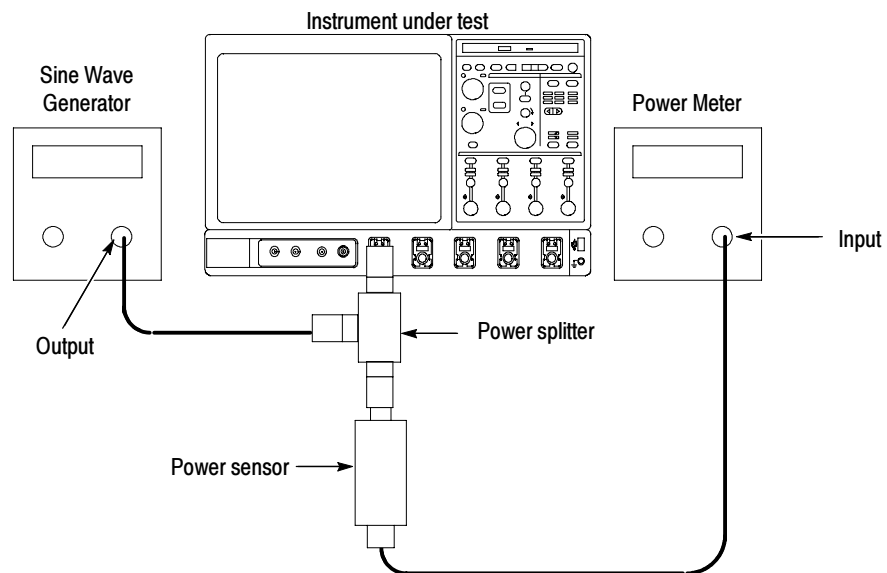

Figure 2-38: Sine wave generator leveling equipment setup

1. *Install the test hookup:* Connect the equipment as shown in Figure 2-38.
2. *Set the Generator:*
 - Set the sine wave generator to a reference frequency of 10 MHz.
 - Adjust the sine wave generator amplitude to the required number of divisions as measured by the instrument.

3. *Record the reference level:* Note the reading on the level meter.
4. *Set the generator to the new frequency and reference level:*
 - Change the sine wave generator to the desired new frequency.
 - Input the correction factor and/or the new frequency into the level meter.
 - Adjust the sine wave generator amplitude until the level meter again reads the value noted in step 3. The signal amplitude is now correctly set for the new frequency.

Equipment required	Sine wave generator (Item 9) Level meter and power sensor (Item 10) Two male N to female BNC adapters (Item 14) Two precision coaxial cables (Item 4) One or two SMA male-to-female BNC adapter (Item 19)
Prerequisites	See page 2-15

1. *Install the test hookup:* Connect the equipment as shown in Figure 2-39 (start with the sine wave generator connected to the instrument).
2. *Set the Generator:*
 - Set the sine wave generator to a reference frequency of 10 MHz.
 - Adjust the sine wave generator amplitude to the required number of divisions as measured by the instrument.

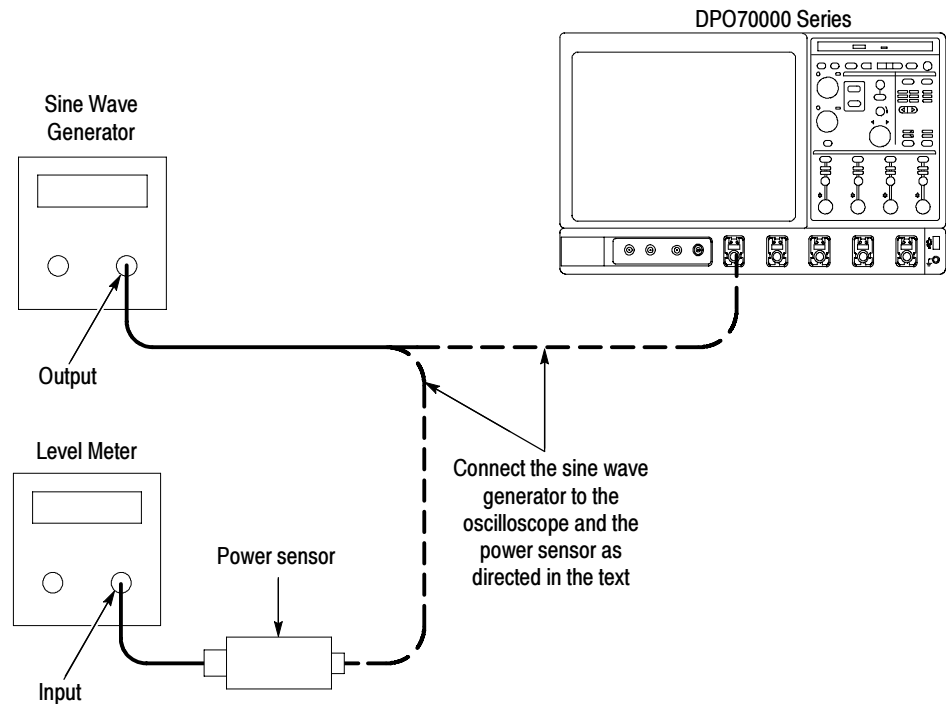

Figure 2-39: Equipment setup for maximum amplitude

3. Record the reference level:

- Disconnect the sine wave generator from the instrument.
- Connect the sine wave generator to the power sensor.
- Note the level meter reading.

4. Set the generator to the new frequency and reference level:

- Change the sine wave generator to the desired new frequency.
- Input the correction factor and/or the new frequency into the level meter.
- Adjust the sine wave generator amplitude until the level meter again reads the value noted in step 3. The signal amplitude is now correctly set for the new frequency.
- Disconnect the sine wave generator from the power sensor.
- Connect the sine wave generator to the instrument.

